

# JVC



## COMPACT COMPONENT SYSTEM 小型組和系統

# MX-V508T/MX-V588T

Consists of CA-V508T and SP-V608  
由 CA-V508T 及 SP-V608 組成

Consists of CA-V588T and SP-V688  
由 CA-V588T 及 SP-V688 組成

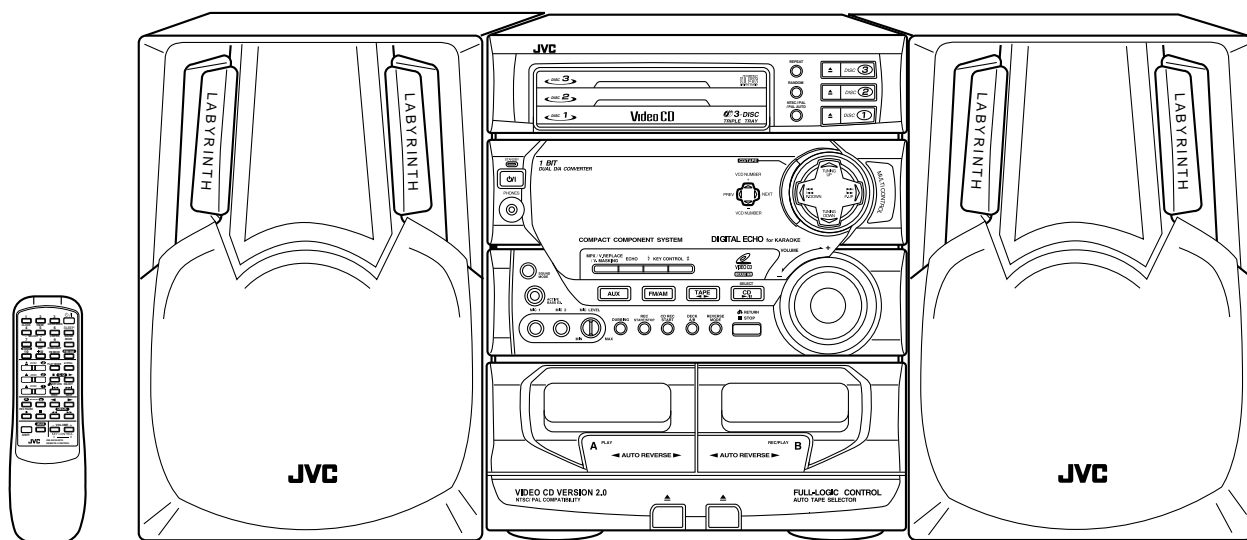

COMPACT  
**disc**  
DIGITAL VIDEO

PlayBack  
Control

COMPACT  
**disc**  
DIGITAL AUDIO  
GRAPHICS

COMPACT  
**disc**  
DIGITAL AUDIO

## INSTRUCTIONS 使用說明書

### For Customer Use:

Enter below the Model No. and Serial No. which are located either on the rear, bottom or side of the cabinet. Retain this information for future reference.

Model No. \_\_\_\_\_

Serial No. \_\_\_\_\_

GVT0006-001A  
[ U, UT, US, UB, UF ]

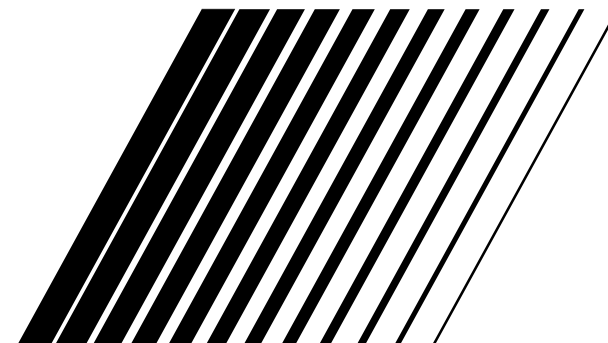

**Warnings, Cautions and Others**  
**Avisos, precauciones y otras notas**  
**Advertências, precauções e outras notas**  
**警告，注意及其他須知事項**  
**تحذيرات، تنبيهات وأشياء أخرى**

**IMPORTANT** for the U.K.

**DO NOT** cut off the mains plug from this equipment. If the plug fitted is not suitable for the power points in your home or the cable is too short to reach a power point, then obtain an appropriate safety approved extension lead or consult your dealer.

**BE SURE** to replace the fuse only with an identical approved type, as originally fitted.

If nonetheless the mains plug is cut off ensure to remove the fuse and dispose of the plug immediately, to avoid a possible shock hazard by inadvertent connection to the mains supply.

If this product is not supplied fitted with a mains plug then follow the instructions given below:

**IMPORTANT.**

**DO NOT** make any connection to the terminal which is marked with the letter E or by the safety earth symbol or coloured green or green-and-yellow.

The wires in the mains lead on this product are coloured in accordance with the following code:

Blue : Neutral  
Brown : Live

As these colours may not correspond with the coloured markings identifying the terminals in your plug proceed as follows:

The wire which is coloured blue must be connected to the terminal which is marked with the letter N or coloured black.

The wire which is coloured brown must be connected to the terminal which is marked with the letter L or coloured red.

**IF IN DOUBT - CONSULT A COMPETENT ELECTRICIAN.**

**Caution — ⏏ switch!**

Disconnect the mains plug to shut the power off completely. The ⏏ switch in any position does not disconnect the mains line. The power can be remote controlled.

**Precaución — Interruptor ⏏!**

Desconectar el cable de alimentación para desactivar la alimentación totalmente. Cualquier que sea la posición de ajuste del interruptor ⏏, la alimentación no es cortada completamente. La alimentación puede ser controlada remotamente.

**Precaução — Interruptor ⏏!**

Desconectar o cabo de alimentação para desligar a alimentação por completo. Qualquer que seja a posição de ajuste do interruptor ⏏, a alimentação não é completamente cortada. A alimentação pode ser controlada remotamente.

**注意— ⏏ 開關！**

無論⏏開關在任何位置，電源線的電源還是沒有被切斷，若要將電源完全關閉，應把電源插頭拔離插座。電源開關可用遙控器控制。

**تحذير - ⏏ الطاقة**

انزع قابس الطاقة الكهربائية من أجل فصل الطاقة الكهربائية عن الجهاز كلياً. لا يفصل مفتاح الطاقة الكهربائية عندما يكون باي وضع ⏏ الطاقة الكهربائية عن الجهاز. يمكن التحكم عن بعد بالطاقة الكهربائية.

**CAUTION**

To reduce the risk of electrical shocks, fire, etc.:

1. Do not remove screws, covers or cabinet.
2. Do not expose this appliance to rain or moisture.

**PRECAUCIÓN**

Para reducir riesgos de choques eléctricos, incendio, etc.:

1. No extraiga los tornillos, los cubiertas ni la caja.
2. No exponga este aparato a la lluvia o a la humedad.

**PRECAUÇÃO**

Para reduzir riscos de choques elétricos, incêndio, etc.:

1. Não remova parafusos e tampas ou desmonte a caixa.
2. Não exponha este aparelho à chuva nem à umidade.

**警告**

為了減低觸電，火災等危險：

1. 請勿擅自卸下螺絲釘，蓋子或機殼。
2. 切勿讓本機受雨淋或置潮濕環境中。

**تحذير**

لتجنب خطر الحريق، الصدمات الكهربائية، الخ:  
١. لا تفك البراغي أو الاغطية أو الخزائنة.  
٢. لا تعرض هذا الجهاز للمطر أو للرطوبة.

**IMPORTANT FOR LASER PRODUCTS / IMPORTANTE PARA PRODUCTOS LÁSER / IMPOTANTE PARA PRODUTOS LASER / 雷射產品的重要說明 / مهم للمنتجات الليزرية**

**REPRODUCTION OF LABELS / REPRODUCCIÓN DE ETIQUETAS / REPRODUÇÃO DE ETIQUETAS**

標籤內容說明 / انتاج الملصقات

- |   |   |
|---|---|
| ① CLASSIFICATION LABEL, PLACED ON REAR ENCLOSURE                                | ② WARNING LABEL, PLACED INSIDE THE UNIT                           |
| ① ETIQUETA DE CLASIFICACIÓN, PEGADA EN LA PARTE POSTERIOR DE LA CAJA            | ② ETIQUETA DE ADVERTENCIA, PEGADA EN EL INTERIOR DE LA UNIDAD     |
| ① ETIQUETA DE CLASSIFICAÇÃO LOCALIZADA NA PARTE POSTERIOR DA CAIXA DO APARELHO. | ② ETIQUETA DE ADVERTÊNCIA LOCALIZADA NA PARTE INTERNA DA UNIDADE. |
| ① 分類標籤，貼在機殼背後。  | ② 警告標籤，貼於機內。  |
| ① ملصق التصنيف، موضوع على المرفق الخلفي   | ② ملصق التحذير، موضوع بداخل الجهاز                                |

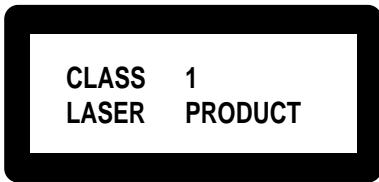

<b>DANGER:</b> Invisible laser radiation when open and interlock failed or defeated. AVOID DIRECT EXPOSURE TO BEAM. (e)	<b>WARNING:</b> Osynlig laserstrålning när denna del är öppnad och spärren är urkopplad. Betrakta ej strålen. (s)	<b>ADVARSEL:</b> Usynlig laserstrålning ved åbning, når sikkerhedsafbrydere er ude af funktion. Undgå udsættelse for stråling (d)	<b>VARO:</b> Avattaessa ja suojalukitus ohitettaessa olet alltiina näkymättömälle lasersäteilylle. Älä katso säteeseen. (f)
---	---	---	---

- |   |  |
|---|--|
| <ol style="list-style-type: none"><li>1. CLASS 1 LASER PRODUCT</li><li>2. <b>DANGER:</b> Invisible laser radiation when open and interlock failed or defeated. Avoid direct exposure to beam.</li><li>3. <b>CAUTION:</b> Do not open the top cover. There are no user serviceable parts inside the Unit; leave all servicing to qualified service personnel.</li></ol>  | <ol style="list-style-type: none"><li>1. 一級鐳射產品</li><li>2. 危險：當內部鎖定裝置失效或者損壞後，打開蓋板可能會產生不可見的雷射輻射。應避免受到光束直接照射。</li><li>3. 注意：請勿打開頂蓋板。本機內部沒有用戶可自行維修的部件；所有維修工作應由有資格的人員完成。</li></ol>   |
| <ol style="list-style-type: none"><li>1. PRODUCTO LÁSER CLASE 1</li><li>2. <b>PELIGRO:</b> En el interior hay radiación láser invisible. Evite el contacto directo con el haz.</li><li>3. <b>PRECAUCIÓN:</b> No abra la tapa superior. En el interior de la unidad no existen piezas reparables por el usuario; deje todo servicio técnico en manos de personal calificado.</li></ol>   | <ol style="list-style-type: none"><li>1. صنف ١ منتج ليزري</li><li>2. <b>خطر:</b> هنالك أشعة ليزرية غير مرئية عند الفتح والاعلاق غير الضروري أو غير الصحيح. تجنّب التعرض المباشر للأشعة.</li><li>3. <b>تحذير:</b> ات تفتح الغطاء العلوي. لا يوجد اجزاء داخل الجهاز يستطيع المستخدم صيانتها. في حالة الحاجة للصيانة، اترك جميع اعمال الصيانة للأشخاص المختصين فقط.</li></ol> |
| <ol style="list-style-type: none"><li>1. PRODUTO LASER CLASSE 1</li><li>2. <b>PERIGO:</b> O laser emite uma radiação invisível que é perigosa, caso o aparelho esteja aberto e a trava inoperante ou danificada. Evite exposição direta ao feixe dos raios.</li><li>3. <b>CUIDADO:</b> Não abra a caixa do aparelho. Não existem peças reparáveis pelo usuário na parte interna da unidade. Solicite assistência técnica somente a pessoal técnico qualificado.</li></ol> |  |



Thank you for purchasing the **JVC** Compact Component System.

We are proud to serve you and we hope this valued addition to your home will give you years of enjoyment.

Please read this instruction manual carefully before operating your new stereo system.

For questions that are not answered in the manual, kindly refer to your dealer.

## Features



PlayBack  
Control



Easy operation



Great sound

Triple Tray

Sing Along

- 1) Types of CDs you can play.  
The Video CD Player can play the following compact discs :
  - **Video CD:** for audio and video (moving picture) reproduction, including multiplex sound.
  - **Video CD with Playback Control function:** featuring menu-type operation and super-fine still pictures for audio and video (moving picture) reproduction, including multiplex sound.
  - **CD Graphics (CD-G):** for audio and video (still picture) reproduction, including multiplex sound.
  - **Digital Audio CD, including single discs:** for audio reproduction.
- 2) The controls and operations have been designed to make them very easy to use, thus you can spend your time listening to music.
  - with the **One Touch Operation** feature of JVC's **COMPU PLAY**, you can turn on the System and start the Radio, Cassette Deck or the CD Player with a single touch.
- 3) The System provides great sound with the following functions :
  - Programmed sound mode includes live surround effects **D. CLUB, HALL, and STADIUM**. It also includes S.E.A. (Surround Effect Amplifier) effects **ROCK, CLASSIC and POP**.
  - The **ACTIVE BASS EXTENDER** provides you with powerful bass to add to your favourite music.
- 4) CD change function can operate 3 discs.
  - Discs can be changed during play using the **TRIPLE TRAY**.
  - Continuous, random or program play of 3 discs.
- 5) Includes a timer for recording broadcasts while you are out, and an easy-to-use Sleep timer.
- 6) You can use conventional tapes and CDs for **Karaoke** with the **Voice Masking** system. With an optional microphone, you can replace the lead's singer voice on your favourite songs with your own.
  - **Digital Echo** applied to your voice through the microphone gives you a professional sound.

## How This Manual Is Organized

In this manual we have incorporated some special features :

- Basic information that is the same for many different functions is grouped in one place, and not repeated in each procedure. For instance, in the section on playing a CD, we do not repeat the information about setting the volume and the sound conditions, which are discussed in the Common Operations section.
- Name of the buttons and controls are written in all capital letters like this: **SOUND MODE**.
- When we are talking about the Function rather than the **BUTTON** or **DISPLAY**, only the first letter is capitalized.

The manual has a table of contents to help you quickly look up what you want to know. We've enjoyed making this manual for you, and hope you will use it to enjoy the sound and many features built into your System.

## IMPORTANT CAUTIONS

1. Installation of the unit
  - Select a place which is level, dry and neither too hot nor too cold. (5°C – 35°C or 41°F – 95°F).
  - Leave sufficient distance between the Unit and a TV.
  - Do not place the Unit in a place subject to vibrations.
2. Power Cord
  - Do not handle the power cord with wet hands!
  - Some power (12 watts) is always consumed as long as the power cord is connected to the wall outlet.
  - When unplugging the Unit from the wall outlet, always pull the plug, not the cord.
3. Malfunctions, etc.
  - There are no user serviceable parts inside. If anything goes wrong, unplug the power cord and consult your dealer.
  - Do not playback CD-ROMs on this equipment. It may generate a noise which can damage your speakers.
  - Do not insert any metallic object into the Unit.

# Table of Contents

Features .....	1	<b>Operation Of Playback Control Function</b>	
How This Manual Is Organized .....	1	<b>(Listening to a Tape).....</b>	<b>22</b>
IMPORTANT CAUTIONS .....	1	Playing Video CDs with Playback	
		Control Function .....	22
		What is the Playback Control PBC function? .....	23
<b>Getting Started .....</b>	<b>3</b>	<b>Graphic CDs .....</b>	<b>24</b>
Accessories .....	3	Playing Graphic CDs .....	24
Set the VOLTAGE SELECTOR Switch .....	3		
How to Put Batteries in the Remote Control .....	3	<b>Various Unique Functions .....</b>	<b>25</b>
Using the Remote Control .....	3	Various Function to Enhance Your Enjoyment .....	25
Connecting the AM Antenna .....	4	Frame-by-Frame Playback .....	25
Connecting the FM Antenna .....	4	Display of Operating Status .....	25
Connecting the Speakers .....	5	Viewing the Video Intro of a Video CD .....	26
Connecting Auxiliary Equipment .....	5	Viewing the Highlight of a Video CD .....	26
Video Out Select .....	6		
COMPU PLAY .....	6	<b>Using the Cassette Deck</b>	
		<b>(Listening to a Tape).....</b>	<b>27</b>
<b>Common Operations .....</b>	<b>7</b>	One touch Play .....	28
Turning the Power On and Off .....	8	Regular Play .....	28
Turning the System On .....	8	Music Scan .....	29
Turning the System Off .....	8	Reverse Mode .....	29
Adjusting the Volume .....	9		
Reinforcing the Bass Sound .....	9	<b>Using the Cassette Deck (Recording) .....</b>	<b>30</b>
Sound Modes .....	9	Standard Recording .....	31
Listening to Auxiliary Equipment .....	10	To reduce the beat during recording AM station .....	32
		CD Direct Recording .....	32
<b>Using the Tuner .....</b>	<b>11</b>	Tape to Tape Recording (Dubbing) .....	32
About the Tuner .....	12		
Setting the AM Tuner Interval Spacing .....	12	<b>Using the Timer .....</b>	<b>33</b>
One Touch Radio .....	12	Setting the Clock .....	33
Tuning In a Station .....	13	Setting the Timer .....	34
Presetting Stations .....	13	Setting the SLEEP Timer .....	35
To Changing the FM Reception .....	14		
		<b>Using the Microphone .....</b>	<b>36</b>
<b>Using the CD Player .....</b>	<b>15</b>	Sing Along–Karaoke .....	37
One Touch CD Player .....	16	To Singing along with conventional audio discs or	
To Insert Discs .....	16	tapes .....	37
		To sing along with Multiplex Karaoke discs or	
		tapes .....	38
<b>Basic of Using the CD Player –</b>		Apply Echo to Your Voice .....	39
<b>Continuous Play .....</b>	<b>17</b>	Adjusting the Music Key Control .....	39
To Play a Discs .....	17	Recording Your Singing Along .....	40
To Select a Disc, Track Or Passage			
Within a Track .....	18	<b>Care And Maintenance .....</b>	<b>41</b>
Locating a Track with the Remote Control			
Control Directly .....	18	<b>Troubleshooting .....</b>	<b>42</b>
To Change Discs While Playing .....	18		
Programming the Playing Order of the Tracks .....	19	<b>Specifications .....</b>	<b>43</b>
Repeating a Selection or the Discs .....	20		
Random Play .....	20		
Tray Lock Function .....	21		

## Accessories

Check that you have all of the following items, which are supplied with the System.

- AC Plug Adaptor (except for Hong Kong and China) (1)
- Remote Control (1)
- Batteries (2)
- AM Loop Antenna (1)
- FM Wire Antenna (1)
- Video Cord (1)

If any of these items is missing, please contact your dealer immediately.

## Set the VOLTAGE SELECTOR Switch

To avoid damaging the System, set the voltage before plugging the Unit into an AC power outlet.

- Set the correct voltage for your area with the **VOLTAGE SELECTOR** switch on the back panel of the System. Use a screwdriver to turn the selector so that the arrow is pointed to the voltage in your area.

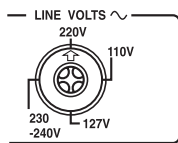

## How To Put Batteries In the Remote Control

The Remote Control requires 2 dry batteries which are supplied. Remove the rear lid of the Remote Control by sliding it out in the direction of the arrow. Insert the batteries by matching the polarity (+ and -) on the batteries with the + and - markings in the battery compartment.

**R6P (SUM-3)/AA (15F)**

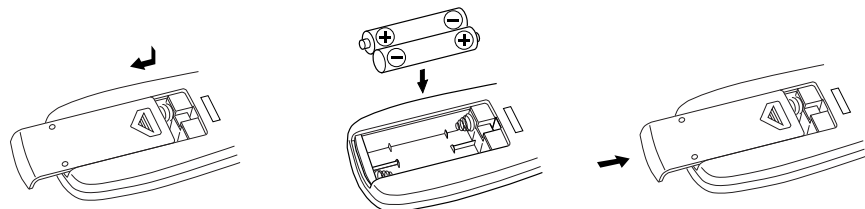

*Caution: Handle batteries properly.*

To avoid battery leakage or explosion:

- Remove batteries when the Remote Control will not be used for a long time.
- Remove used batteries and replace both batteries at the same time with new ones.
- Don't use an old battery with a new one.
- Don't use different types of batteries together.

## Using the Remote Control

The Remote Control enables you to control many functions of the System from a distance of up to 7m (23feet) away.

When using the Remote Control, point the Remote Control at the remote sensor on the System's front panel.

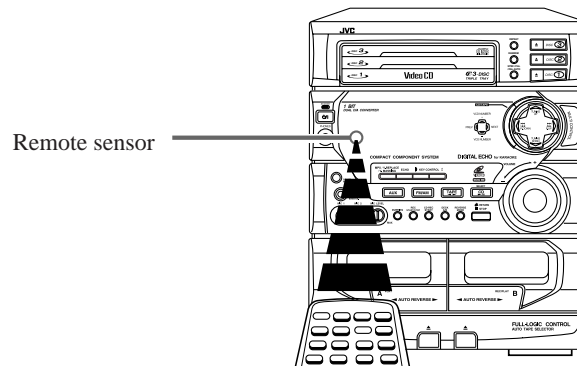

CAUTION: Make all connections before plugging the Unit into an AC power outlet.

## Connecting the AM Antenna

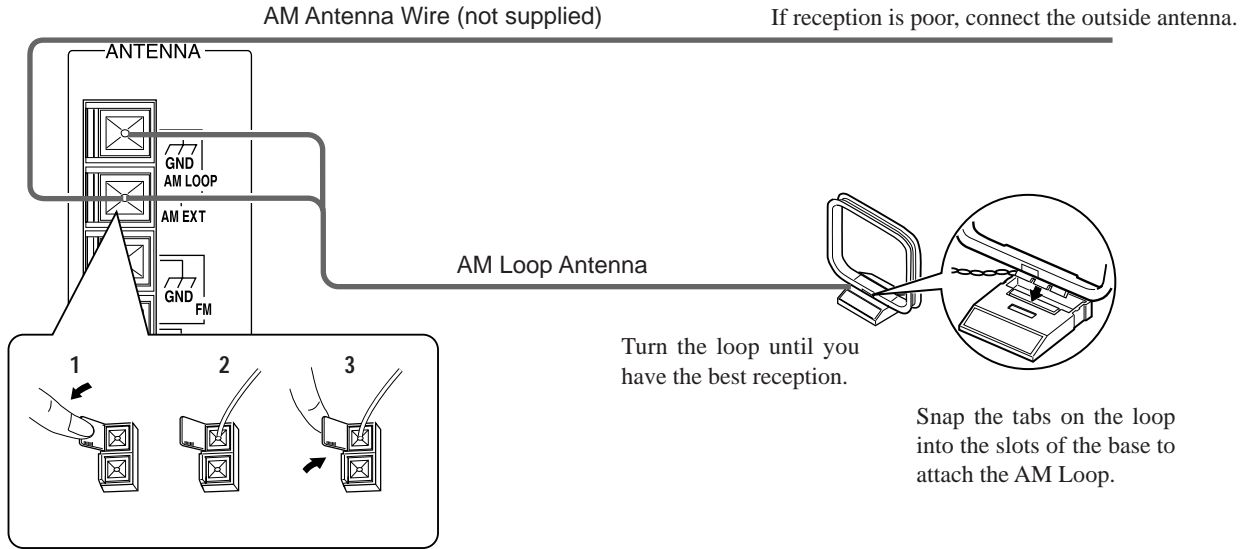

Note: Even when an outdoor AM Antenna is used, keep the indoor AM Loop Antenne connected.

## Connecting the FM Antenna

### Using the Supplied FM Wire Antenna

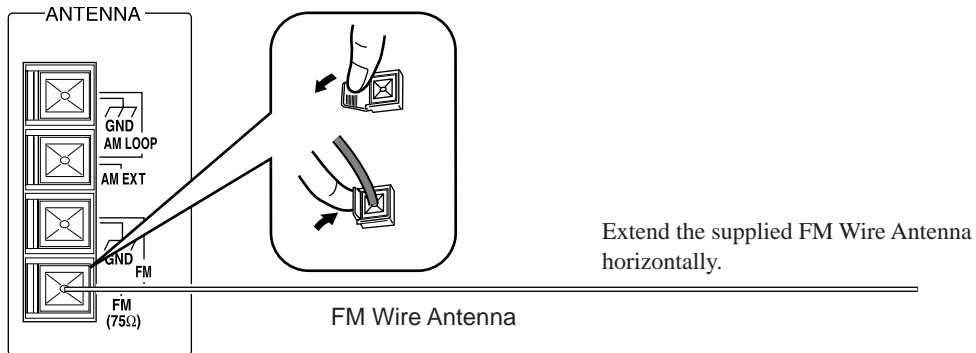

### Using a 75Ohm FM Wire Antenna (Not Supplied)

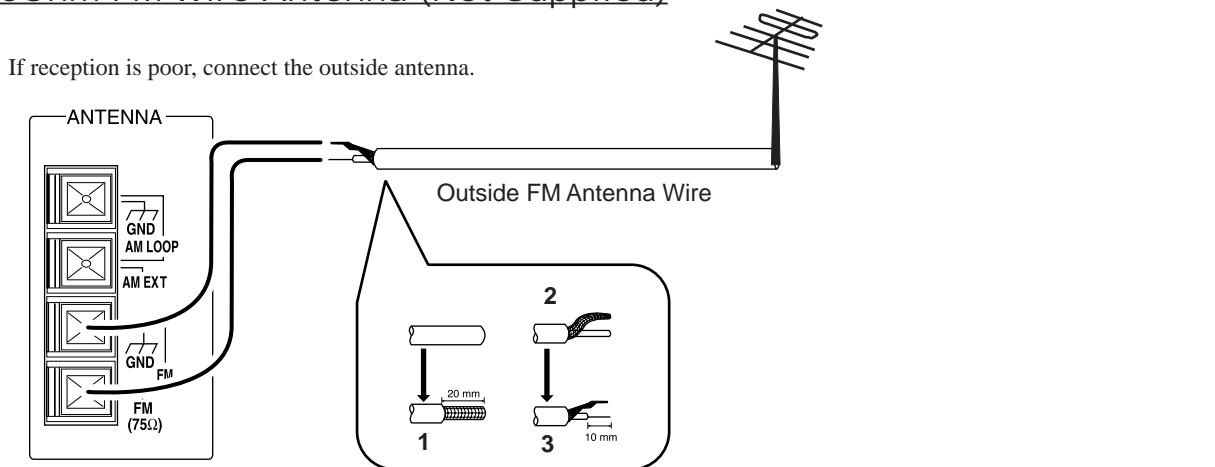

Before attaching a 75-ohm coaxial lead (the kind with a round wire going to an outside antenna), disconnect the supplied FM Wire Antenna.

CAUTION: To avoid noise, keep antennas away from metallic parts of the System, connecting cord and the AC power cord.



CAUTION: Make all connections before plugging the Unit into an AC power outlet.

## Connecting the Speakers

- Please refer to instructions for speakers as well when you connect the speakers.

For each speaker, connect one end of the speaker wire to the speaker terminals on the back of the System. Open each of the terminals and insert the speaker wires firmly, then close the terminals.

Note :

1. Connect the **Red (+)** and **Black (-)** wires of the right side speaker to the **Red (+)** and **Black (-)** terminals marked **RIGHT** on the System.
2. Connect the **Red (+)** and **Black (-)** wires of the left side speaker to the **Red (+)** and **Black (-)** terminals marked **LEFT** on the System.

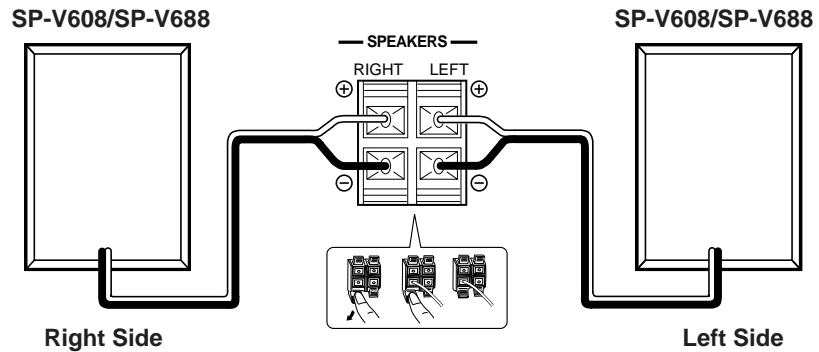

**IMPORTANT :** Use speakers with the correct impedance only. Allowed speaker impedance is 6-16 ohm.

**CAUTION:** If a TV is installed near the speakers, the TV may display irregular colours. In this case, locate the speakers away from the TV.

## Connecting Auxiliary Equipment

You can connect the following equipment to this System.

- **TV with a video input jack:** used as a monitor of Video CD playback.
- **Video/Audio equipment.**

Note :

1. Connect the **VIDEO OUT** jack at the back panel of the System to the video input jack on the TV via the supplied video cord.
2. Connect the **AUX** ports to the audio input and output of VCR/Audio equipment.
3. The **AUX OUT** ports will transmit audio signals from the selected **TAPE, CD** or **TUNER**, to the connected equipment. No audio signal is produced at the **AUX IN** port.

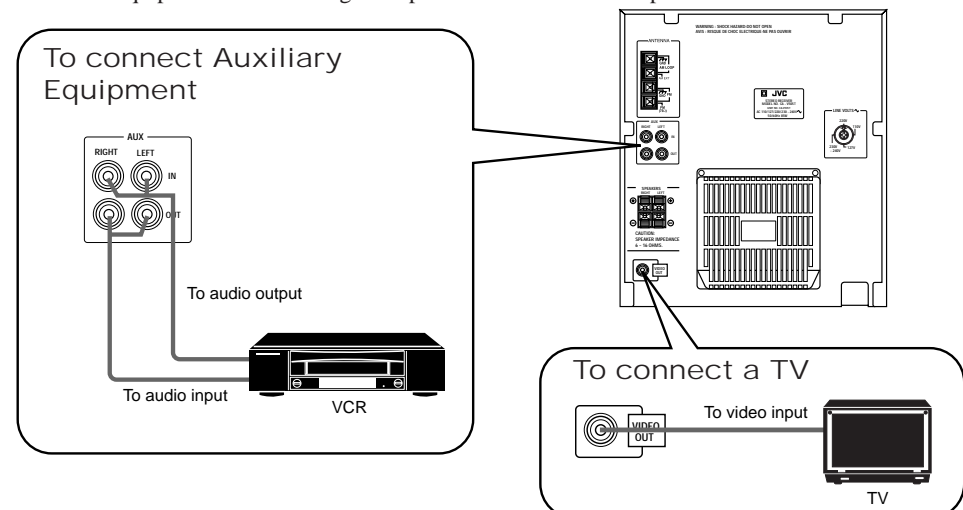

## Video Out Select

NTSC / PAL  
/ PAL AUTO



Set the **NTSC / PAL / PAL AUTO** button on the front panel to **NTSC**, **PAL** or **PAL AUTO** mode according to your television system.

**NTSC** ..... for **NTSC** exclusive TV.

**PAL** ..... for **PAL** exclusive TV.

**PAL AUTO** ..... for Multisystem TV.

**PAL AUTO** detects the formula of the disc (**NTSC/PAL**) automatically and plays the image on the screen correctly.

*Note :*

- Select the mode before you play the disc. If you change the mode during play, images may get distorted. In this situation, stop the player and reset the mode.
- When you play an **NTSC** disc in **PAL AUTO** mode on a **PAL** exclusive TV, the image may be distorted. If this happens, change the mode to “PAL”.
- When you play an **NTSC** disc in **PAL AUTO** mode on a Multisystem TV, the image may blink for a moment. This symptom is caused by the Player detecting the formula of the disc, not by a malfunction of the Player.

You can plug the AC power cord into the wall outlet.

Your System is ready for action and it is just waiting for your command!

## COMPU PLAY

**COMPU PLAY** is JVC's feature that allows you to control the most frequently used functions of the System with a single touch.

**One Touch Operation** starts playing a CD, turns on the radio, plays a tape, etc. with a single press of the play button for that function. What it does is that it will turn on the power and then start the function specified. If the Unit is still not loaded with a CD or tape, the Unit still powers on and you can insert a CD or tape.

Please refer to the section dealing with the specified function for further details.

The **COMPU PLAY** buttons on the Unit and Remote Control are as follow :

No	Unit	Remote Control
1	CD Player <b>DISC 1</b> to <b>DISC 3</b> buttons	CD control <b>DISC 1</b> to <b>DISC 3</b> buttons
2	CD Player Open / Close (▲) buttons	CD control Open / Close (▲) buttons
3	CD (▶/  ) <b>SELECT</b> button	CD control (▶) <b>SELECT</b> button
4	(◀ TAPE ▶) button	Deck control (◀, ▶) buttons
5	<b>FM/AM</b> button	<b>FM/AM</b> button
6	<b>AUX</b> button	<b>AUX</b> button

# Common Operations

Unit (Front Panel)

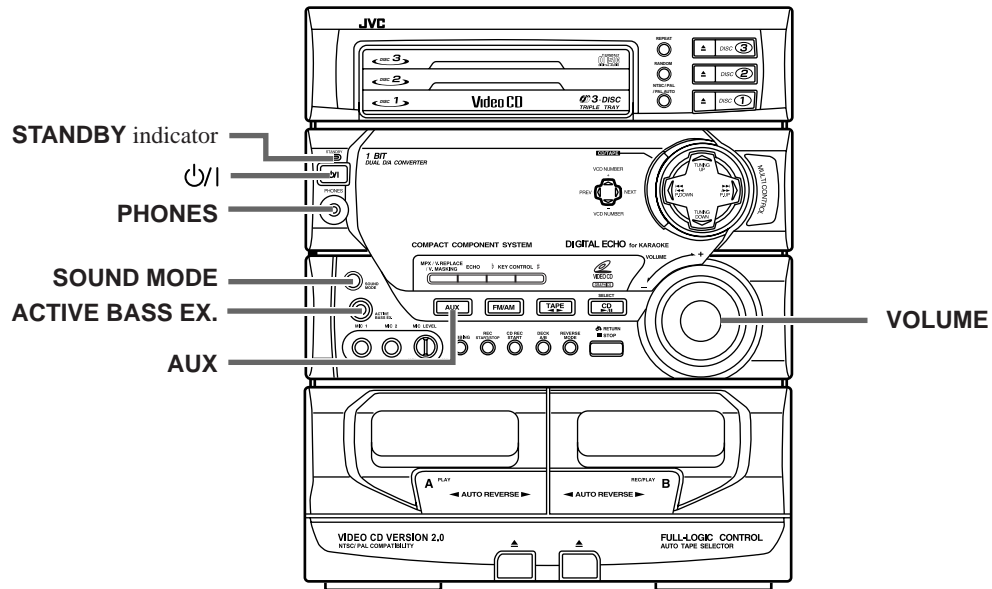

Remote Control

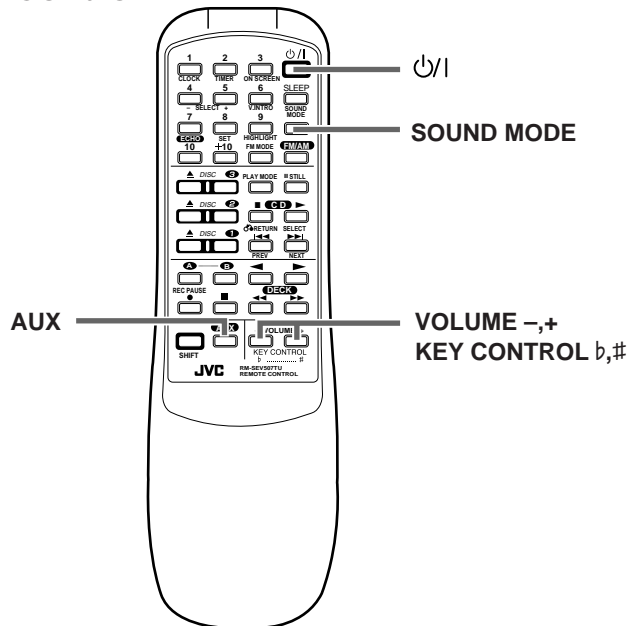

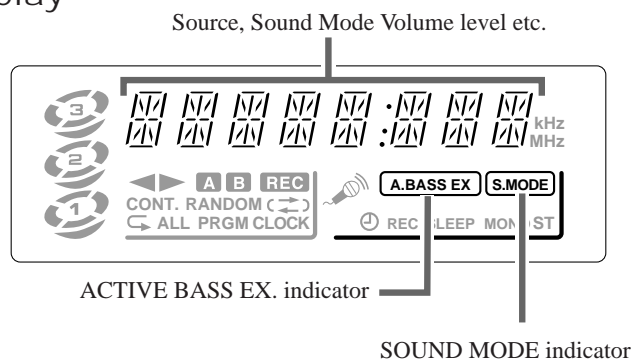

Display



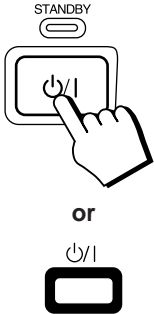

When the System is being used, the display shows other items as well. However, we have only shown the items described in this section.

# Turning the Power On and Off

## Turning the System On

Unit/Remote Control	Steps	Explanation/Remarks
 <p>The diagram shows two methods for turning the system on. On the left, a hand is shown pressing a button on the front of the unit labeled 'STANDBY' with a power symbol. Below this, the word 'or' is written, followed by a separate icon of a remote control with a power button being pressed.</p>	<p><b>On the Unit</b></p> <ol style="list-style-type: none"> <li>1. Press the (  ) <b>STANDBY</b> button.</li> </ol> <p><b>On the Remote Control</b></p> <ol style="list-style-type: none"> <li>1. Press the (  ) button.</li> </ol>	<ol style="list-style-type: none"> <li>1. The display lights up and the <b>STANDBY</b> indicator goes out.</li> <li>2. The System comes on ready to continue in the mode it was in when the power was last turned off.</li> </ol> <p><b>Example:</b></p> <ul style="list-style-type: none"> <li>• If the last thing you were doing was listening to a tape in Deck B, you are now ready to listen to a tape again in Deck B, or you can change to another source.</li> <li>• If you were listening to the Tuner last, the Tuner comes on playing the station it was last set to.</li> </ul>

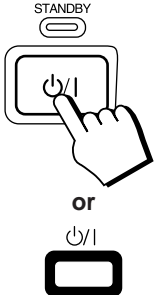
## Turning the System Off

Unit/Remote Control	Steps	Explanation/Remarks
 <p>The diagram shows two methods for turning the system off. On the left, a hand is shown pressing a button on the front of the unit labeled 'STANDBY' with a power symbol. Below this, the word 'or' is written, followed by a separate icon of a remote control with a power button being pressed.</p>	<p><b>On the Unit</b></p> <ol style="list-style-type: none"> <li>1. Press the (  ) <b>STANDBY</b> button again.</li> </ol> <p><b>On the Remote Control</b></p> <ol style="list-style-type: none"> <li>1. Press the (  ) button again.</li> </ol>	<ol style="list-style-type: none"> <li>1. The <b>STANDBY</b> indicator lights up and the display is blank, except for the clock display.</li> <li>2. Some power (12W) is always consumed even though power is turned off (Standby Mode).</li> <li>3. To switch off the Unit completely, unplug the AC power cord from the AC outlet. When you unplug the AC power cord, the clock will reset to 0:00 immediately and the preset radio stations will be erased after a few days.</li> </ol>

## Adjusting the Volume

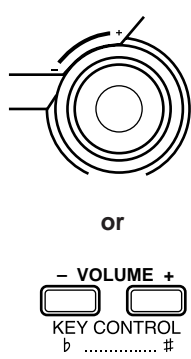
Unit/Remote Control	Steps	Explanation/Remarks
 <p>or</p> <p>- VOLUME + KEY CONTROL b ..... #</p>	<p><b>On the Unit</b></p> <ol style="list-style-type: none"> <li>Turn the <b>VOLUME</b> control.</li> </ol> <p><b>On the Remote Control</b></p> <ol style="list-style-type: none"> <li>Press the <b>VOLUME +</b> to increase the volume and <b>VOLUME -</b> pressing the will decrease the volume.</li> </ol>	<ol style="list-style-type: none"> <li>Turn the control clockwise to increase the volume or anti-clockwise to decrease it. Turning the <b>VOLUME</b> control quickly will change the volume level quickly too.</li> <li>The volume level is adjustable between 0 and 50.</li> <li>For private listening, connect headphones to the <b>PHONE</b> jack. Turn down the volume before connecting the headphones. The speakers will be silent.</li> <li><b>Caution:</b> The volume cannot be adjusted while the Unit is in <b>STANDBY</b> mode. <b>DO NOT</b> turn on the Unit or start playing any source without setting the <b>VOLUME</b> control to 0; otherwise the sudden blast of sound may damage your hearing, speakers or headphones.</li> </ol>

## Reinforcing the Bass Sound

This is used to maintain the richness and fullness of the bass sound regardless of how low the volume is set. This function can only be used for playback.

Unit	Steps	Explanation/Remarks
 <p>ACTIVE BASS EX.</p>	<p><b>On the Unit</b></p> <ol style="list-style-type: none"> <li>Press the <b>ACTIVE BASS EX.</b> button.</li> <li>To cancel, press the above button again.</li> </ol>	<ol style="list-style-type: none"> <li>The frame around the <b>A. BASS EX.</b> indicator lights up.</li> <li>When canceled, the frame around the <b>A. BASS EX.</b> disappears.</li> </ol>

## Sound Modes

The System has 6 preset (other than the original) sound effects to tailor to your listening pleasure. You can apply one of the preset modes to increase the sound effect based on your room. It will also increase the quality of the source. The preset modes include modes using Surround Effects modes and S.E.A. modes. Sound Mode effects cannot be recorded.

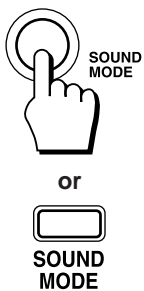

Surround Effect Modes		S.E.A. Effect Modes	
<b>D.CLUB (Dance Club)</b>	Increases resonance and bass.	<b>ROCK</b>	Boosts low and high frequencies.
<b>HALL</b>	Adds depth and brilliance to the sound, like in a concert hall.	<b>CLASSIC</b>	Set for wide and dynamic sound stereo systems.
<b>STADIUM</b>	Adds clarity and spreads the sound, like in an outdoor stadium.	<b>POP</b>	Excellent for vocal music.

Unit/Remote Control	Steps	Explanation/Remarks
 <p>or</p> <p>SOUND MODE</p>	<p><b>On the Unit/Remote Control</b></p> <ol style="list-style-type: none"> <li>Press the <b>SOUND MODE</b> button.</li> <li>To cancel, press the above button until <b>FLAT</b> appears on the display.</li> <li>To show the current <b>SOUND MODE</b> on the display, press the <b>SOUND MODE</b> button again.</li> </ol>	<ol style="list-style-type: none"> <li>Press repeatedly until the Sound Mode you want appears in the display. The frame around <b>S. Mode</b> indicator lights up.</li> <li>Each time the button is pressed, the display changes as shown : → <b>D.CLUB</b> → <b>HALL</b> → <b>STADIUM</b> → <b>ROCK</b> → <b>CLASSIC</b> → <b>POP</b> → <b>FLAT</b> → (back to the original)</li> <li>When canceled, the frame around <b>S. MODE</b> goes off.</li> </ol>

## Listening to Auxiliary Equipment

By playing the sound from the auxiliary equipment through the System, you can gain control over how the music or program sounds. Once the connected equipment is playing through the System, you can apply the sound effects.

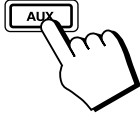
Make sure that the external equipment is properly connected to the System (See page 5).

Unit/Remote Control	Steps	Explanation/Remarks
 <p>or</p> 	<p><b>On the Unit/Remote Control</b></p> <ol style="list-style-type: none"> <li>1. Set the <b>VOLUME</b> control to 0.</li> <li>2. Press the <b>AUX</b> button.</li> <li>3. Start playing the external equipment.</li> <li>4. Adjust the <b>VOLUME</b> control to the desired level.</li> <li>5. To cancel, change setting to any of the System's in-built sources, such as the Tuner or CD Player</li> </ol>	<ol style="list-style-type: none"> <li>1. After pressing the <b>AUX</b> button, "<b>AUX</b>" will appear on the display. If the System is in Standby mode, the Unit is automatically turned on to "<b>AUX</b>".</li> <li>2. Select a sound mode, if you wish (See page 9).</li> </ol>

# Using the Tuner

## Unit (Front Panel)

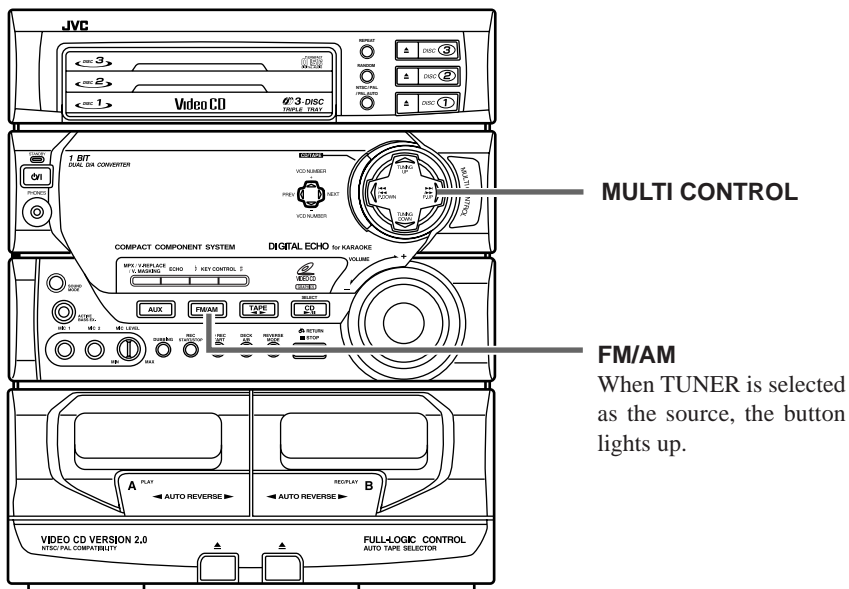

## Remote Control

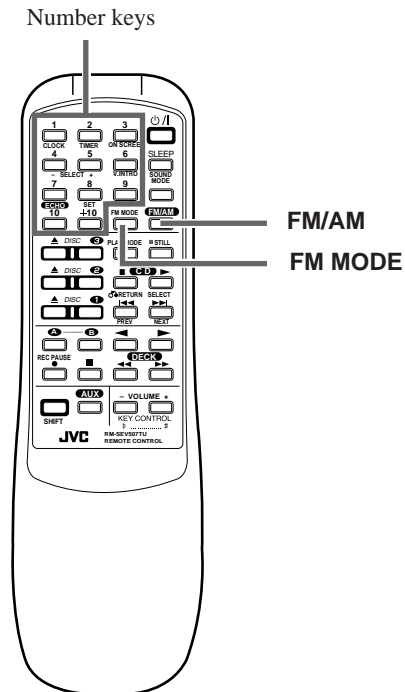

## Display

Band display, Frequency display, Preset channel

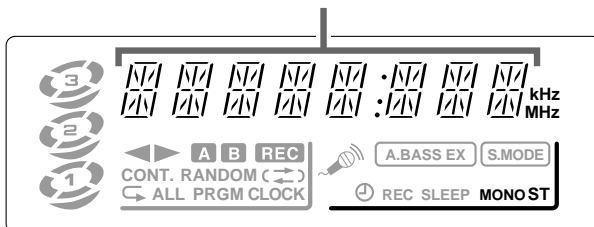

When the System is being used, the display shows other items as well. However, we have only shown the items described in this section.

## About the Tuner

You can listen to both FM and AM stations. Stations can be tuned in manually, automatically or from preset memory storage. Before listening to the radio, check that both the FM and AM antennas are properly connected (See page 4).

## Setting the AM Tuner Interval Spacing

Some countries space AM stations 9 kHz apart, while others use 10 kHz spacing.

	9 kHz spacing	10 kHz spacing
<b>Country</b>	Europe United Kingdom Australia Others	Canada United States Other Western Hemisphere countries

When shipped, the System is set to 9 kHz spacing. In case of Brazil, the System is set to 10kHz spacing.

To select the 10 kHz interval:

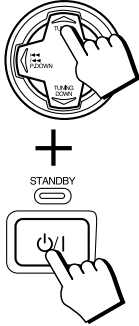
Unit	Steps	Explanation/Remarks
	<p><b>On the Unit</b></p> <ol style="list-style-type: none"> <li>1. Press the (⏻) <b>STANDBY</b> button while pressing the <b>TUNING UP</b> button.</li> </ol>	<ol style="list-style-type: none"> <li>1. The unit must be in STANDBY mode.</li> <li>2. “<b>AM-10</b>” appears on the display.</li> </ol>

To select/change back to 9 kHz interval:

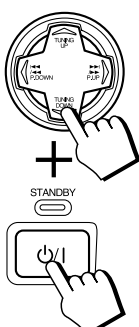
Unit	Steps	Explanation/Remarks
	<p><b>On the Unit</b></p> <ol style="list-style-type: none"> <li>1. Press the (⏻) <b>STANDBY</b> button while pressing the <b>TUNING DOWN</b> button.</li> </ol>	<ol style="list-style-type: none"> <li>1. The unit must be in STANDBY mode.</li> <li>2. “<b>AM-9</b>” appears on the display.</li> </ol>

## One Touch Radio

Unit/Remote Control	Steps	Explanation/Remarks
	<p><b>On the Unit/Remote Control</b></p> <ol style="list-style-type: none"> <li>1. Press the <b>FM/AM</b> button.</li> </ol>	<ol style="list-style-type: none"> <li>1. The unit will turn on and starts to play the last station tuned in. The Frequency will appear on the display.</li> <li>2. Each time you press the button, the band alternates between <b>FM</b> and <b>AM</b>.</li> <li>3. You can switch from any other sound source to the radio by pressing the <b>FM/AM</b> button.</li> </ol>



## Tuning In a Station

There are 3 ways to select a station : **Manual Tuning, Auto Tuning, Preset.**

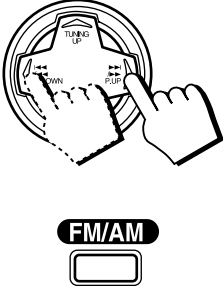
Unit/Remote Control	Steps	Explanation/Remarks
	<p><b>Manual Tuning:</b> <b>On the Unit</b></p> <ol style="list-style-type: none"> <li>1. Press the <b>FM/AM</b> button.</li> <li>2. Press the <b>TUNING DOWN</b> or <b>TUNING UP</b> button on the <b>MULTI CONTROL</b> repeatedly.</li> </ol>	<ol style="list-style-type: none"> <li>1. The radio turns on.</li> <li>2. The frequency will shift from frequency to frequency until you find the one you want.</li> </ol>
	<p><b>Auto Tuning:</b> <b>On the Unit</b></p> <ol style="list-style-type: none"> <li>1. Press the <b>FM/AM</b> station.</li> <li>2. Press and hold the <b>TUNING DOWN</b> or <b>TUNING UP</b> button on the <b>MULTI CONTROL</b> for a few seconds.</li> </ol>	<ol style="list-style-type: none"> <li>1. The radio turns on.</li> <li>2. When a station is tuned in, the frequency stops changing.</li> </ol>
	<p><b>Preset:</b> <b>On the Unit</b></p> <ol style="list-style-type: none"> <li>1. Press once and release the <b>PREV ◀◀ P.DOWN</b> or <b>NEXT ▶▶ P.UP</b> button on the <b>MULTI CONTROL</b> to go to the next preset station.</li> </ol> <p><b>On the Remote Control</b></p> <ol style="list-style-type: none"> <li>1. Press the <b>FM/AM</b> station.</li> <li>2. Select the station by entering the preset number in the number keys of the Remote Control.</li> </ol>	<ol style="list-style-type: none"> <li>1. This function is only possible after presetting stations (refer to <b>Presetting Stations</b> below).</li> <li>1. After the preset number is selected and the number is displayed, the broadcast frequency of the selected channel will appear on the display.</li> </ol>

## Presetting Stations

You can preset up to 30 FM stations and 15AM stations for the preset numbers.

Note : In some cases, test frequencies have been already memorized for the tuner since the factory examined the tuner preset function before shipment. This is not a malfunction. You can preset the stations you want into memory by following the presetting method.

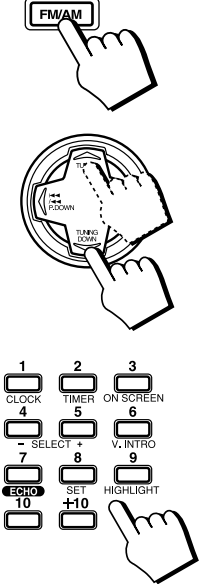
Unit/Remote Control	Steps	Explanation/Remarks
	<p><b>On the Unit</b></p> <ol style="list-style-type: none"> <li>1. Press the <b>FM/AM</b> button.</li> <li>2. Press the <b>TUNING DOWN</b> or <b>TUNING UP</b> button on the <b>MULTI CONTROL</b>.</li> <li>3. Press the number keys on the Remote Control continuously.</li> <li>4. Repeat steps 1-3 for each station you want to store to a preset number.</li> </ol> <p><b>Notes :</b> <b>Preset numbers 1 to 10:</b> Press the number key for the required one. <b>Preset numbers 11 to 20:</b> Press 1 to 10 after pressing +10 button. <b>Preset numbers 21 to 30:</b> Press 1 to 10 after pressing +10 button twice.</p>	<ol style="list-style-type: none"> <li>1. This will select the band (FM or AM).</li> <li>2. The frequency will shift from frequency to frequency until you find the one you want.</li> <li>3. The preset number appears on the display after you have pressed the number keys. If the key is pressed continuously, the preset number blinks. Release the button after the number starts to blink. This completes the preset setting.</li> </ol> <div style="border: 1px solid black; padding: 5px; margin-top: 10px;"> <p><b>CAUTION:</b> If the Unit is unplugged or if a power failure occurs, the preset stations will be erased in a few days. If this happens, preset the station again.</p> </div>

## To Change the FM Reception

When an FM stereo broadcast is noisy or hard to receive, changing the following will improve the situation.

Remote Control	Steps	Explanation/Remarks
<p data-bbox="228 349 307 371"><b>FM MODE</b></p> 	<p data-bbox="432 309 694 331"><b><u>On the Remote Control</u></b></p> <ol data-bbox="432 338 746 360" style="list-style-type: none"><li data-bbox="432 338 746 360">1. Press the <b>FM MODE</b> button.</li></ol>	<ol data-bbox="884 338 1417 421" style="list-style-type: none"><li data-bbox="884 338 1417 421">1. The <b>ST</b> indicator goes off and the <b>MONO</b> indicator appears. The received broad cast will become monaural.</li></ol>

# Using the CD Player

## Unit (Front Panel)

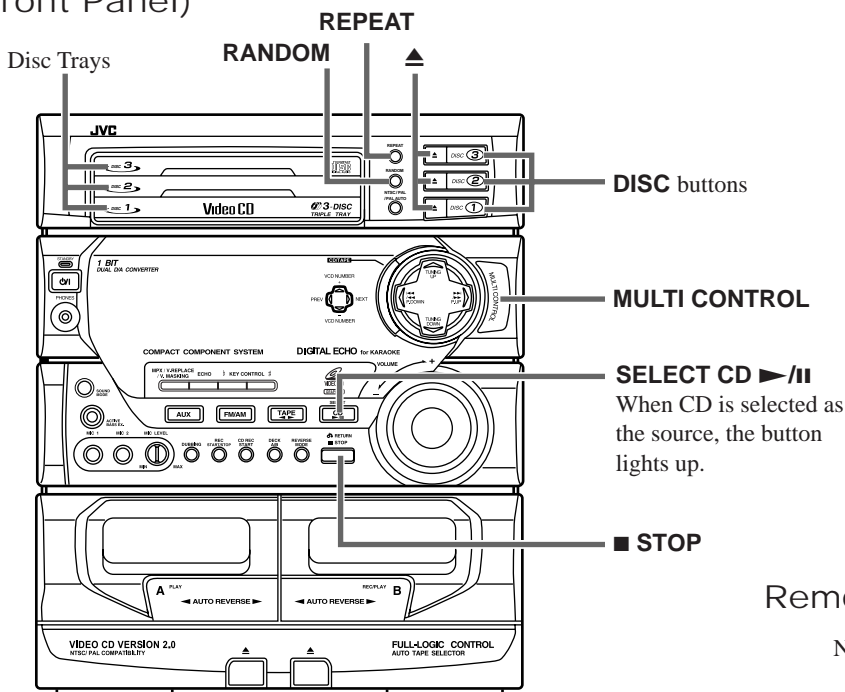

## Remote Control

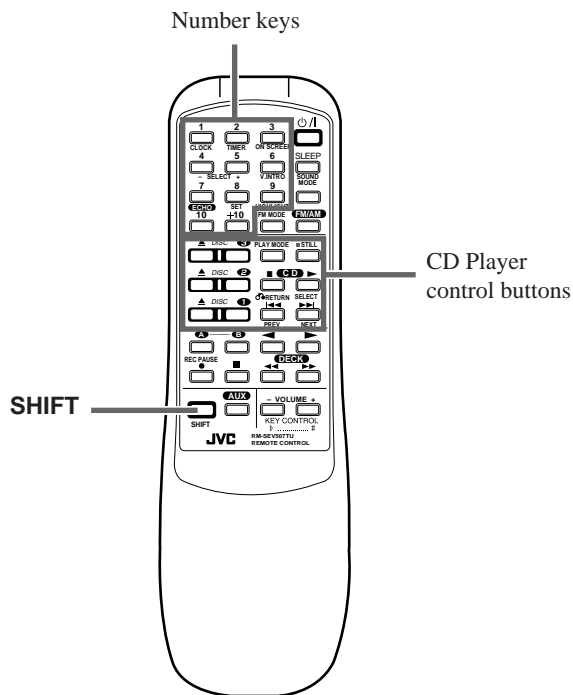

## Display

Disc indicators      Track number, Playing time, step number

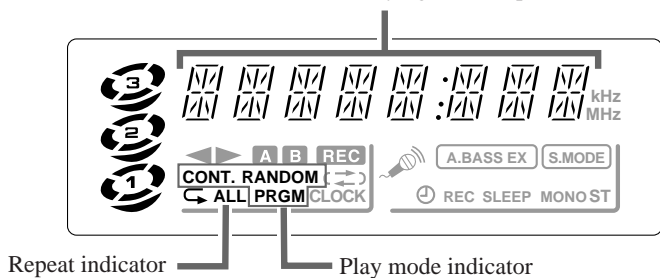

When the System is being used, the display shows other items as well. However, we have only shown the items described in this section.

**Disc marker**

**Disc indicators**  
A disc marker lights up for the disc number you have selected. The disc indicator blinks while a CD is being played.  
The disc indicator goes off when CD Player has detected that there is no disc in the disc tray.

The System's CD Player has an Automatic Change with 3 disc trays. You can use Random, Program or Repeat Play for the discs in DISC 1, DISC 2 and DISC 3. Repeat Play can repeat all the tracks on all the CDs or one track on one CD. There is also the Tray Lock function, which safely keeps discs in the trays.

Here are some basic things you need to know in order to operate a CD and locate the different selections on it, Each selection is called a track, so when we are talking about locating a track, we are also talking about how you find a certain song or performance.

# One Touch CD Player

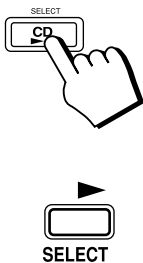

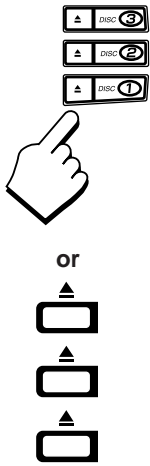
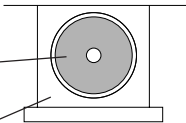
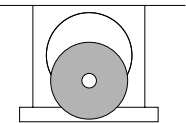

Unit/Remote Control	Steps	Explanation/Remarks
	<p><b>On the Unit</b></p> <ol style="list-style-type: none"> <li>1. Press the <b>SELECT (▶/II)</b> button.</li> </ol> <p><b>On the Remote Control</b></p> <ol style="list-style-type: none"> <li>1. Press the <b>(▶) SELECT</b> button.</li> </ol> <p><b>Notes:</b></p> <ul style="list-style-type: none"> <li>• If you press any one of the <b>(▲)</b> buttons (for DISC 1-3), the power is automatically turned on and the selected disc tray comes out.</li> <li>• If you press any one of the <b>DISC (1-3)</b> button, the power is automatically turned on. Only if the System is in Continuous Play mode, the System starts searching for disc and then starts playing if a disc is found.</li> </ul>	<ol style="list-style-type: none"> <li>1. The unit will turn on and the System starts searching for CDs.</li> <li>2. If a disc is found, the System starts playing the previously selected play mode (Continuous Play, Random Play or Program Play : for each mode see the related pages)</li> <li>3. If there is no disc loaded on any trays, "NO DISC" will appear on the display. Playback will not start.</li> </ol>

## To Insert Discs

Unit/Remote Control	Steps	Explanation/Remarks
	<p><b>On the Unit/Remote Control</b></p> <ol style="list-style-type: none"> <li>1. Press the <b>(▲)</b> button on the left of the Disc button you want to insert the disc into.</li> <li>2. Place a CD with its label side up onto the tray.</li> <li>3. Press the <b>(▲)</b> to close the tray.</li> </ol> <p><b>Caution:</b> Do not push the tray back as it may destroy the tray mechanism or break the tray.</p>	<ol style="list-style-type: none"> <li>1. The disc tray slides out automatically.</li> <li>2. Place the CD in the right location at the center of the tray as shown below:</li> </ol> <div style="display: flex; justify-content: space-around; align-items: center;"> <div style="text-align: center;">  <p><b>CORRECT</b></p> </div> <div style="text-align: center;">  <p><b>INCORRECT</b></p> </div> </div> <ul style="list-style-type: none"> <li>• For an 8 cm CD (Single), load it so that it is aligned with the groove in the tray's center.</li> </ul> <ol style="list-style-type: none"> <li>3. If a tray is opened when the System switches to Standby mode, the tray will close automatically.</li> </ol>

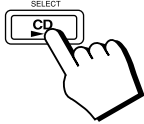
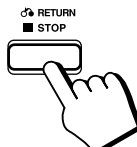
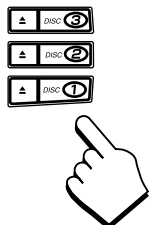
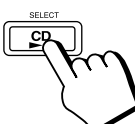
# Basics of Using the CD Player – Continuous Play

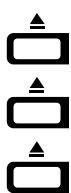
## To Play a Disc

Unit/Remote Control	Steps	Explanation/Remarks
<p><b>1</b></p>  <p><b>2</b></p>  <p><b>3</b></p>  <p><b>4</b></p> 	<p>1. Insert a disc into one of the disc trays.</p> <p><b>On the Unit</b></p> <p>1. To Play: Press the <b>SELECT CD (▶/  )</b> or <b>DISC (1-3)</b> buttons of the disc you want to play.</p> <p>2. To Stop: Press the <b>(⏪) RETURN (■) STOP</b> button for the disc being played.</p> <p>3. To Stop and Remove the disc: For both the Unit and Remote Control, press the <b>(▲)</b> button.</p> <p>4. To Pause: Press the <b>SELECT CD (▶/  )</b> button while playing.</p> <p>5. To Cancel Pause: Press the <b>SELECT CD (▶/  )</b> button again.</p>	<p>1. If a Video CD is inserted, “VIDEO CD” will appear in the display.</p> <p><b>Note :</b></p> <ul style="list-style-type: none"> <li>If the CD can't be read correctly (due to scratches, misalignment etc.) “01 00:00” appears on the display.</li> </ul> <p>2. The first track of the selected disc will begin playing.</p> <p>3. The CD Player automatically searches next tray when playback finishes the last track of the CD.</p> <p>4. If the <b>PLAY</b> button is pressed while the tray is open, the tray is automatically closed and playback begins.</p> <p>5. When Pausing the CD, the Disc playing time will blink.</p> <p>6. When resuming a Paused CD, play continues from the point where it was paused.</p>
<p><b>1</b></p>  <p><b>2</b></p>  <p><b>3</b></p>  <p><b>4</b></p>  <p><b>5</b></p> 	<p><b>On the Remote Control</b></p> <p>1. To Play: Press <b>(▶) SELECT</b> button or the <b>DISC (1-3)</b> buttons.</p> <p>2. To Stop: Press the <b>(⏪) RETURN (■)</b> button.</p> <p>3. To Stop and Remove the disc: Press the <b>(▲)</b> button.</p> <p>4. To Pause: Press the <b>(  ) STILL</b> button.</p> <p>5. To Cancel Pause: Press <b>(▶) SELECT</b> button.</p>	

## To Select a Disc, Track Or Passage Within a Track

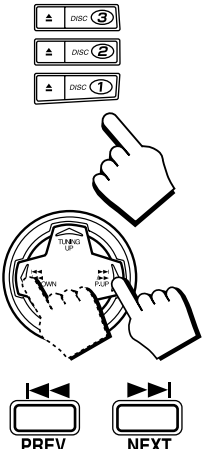
Unit/Remote Control	Steps	Explanation/Remarks
	<p><b>On the Unit</b></p> <ol style="list-style-type: none"> <li>1. Press the <b>DISC (1-3)</b> button.</li> <li>2. Press the <b>(◀◀) P.DOWN (PREV)</b> or <b>(▶▶) P.UP (NEXT)</b> on the <b>MULTI CONTROL</b>.</li> </ol> <p><b>On the Remote Control</b></p> <ol style="list-style-type: none"> <li>1. Press the <b>DISC (1-3)</b> button.</li> <li>2. Press the <b>(◀◀) PREV</b> or <b>(▶▶) NEXT</b>.</li> </ol>	<ol style="list-style-type: none"> <li>1. This will select the disc tray containing the track you want to listen to.</li> <li>2. The selected track starts playing.</li> <li>3. Each time the <b>(◀◀) P.DOWN (PREV)</b> or <b>(▶▶) P.UP (NEXT)</b> on the Unit [ <b>(◀◀) PREV</b> or <b>(▶▶) NEXT</b> on the remote Control ] is pressed briefly and released, the track changes by one.</li> <li>4. Press and release the <b>(◀◀) P.DOWN (PREV)</b> [ <b>(◀◀) PREV</b> ] button to go back one track at a time.</li> <li>5. Press and release the <b>(▶▶) P.UP (NEXT)</b> [ <b>(▶▶) NEXT</b> ] button to go ahead one track at a time.</li> <li>6. Press and holding down the buttons during playback will fastforward/backwards the CD. This will enable you to quickly find a particular passage in the selection you are listening to.</li> </ol>

## Locating a Track with the Remote Control Directly

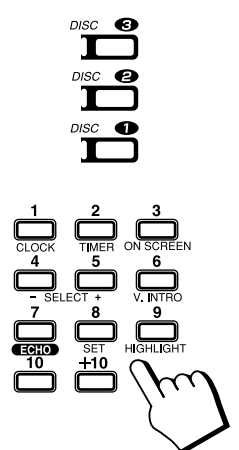
Remote Control	Steps	Explanation/Remarks
	<p><b>On the Remote Control</b></p> <ol style="list-style-type: none"> <li>1. Press the <b>DISC (1-3)</b> button.</li> <li>2. Enter the number of the track.</li> </ol> <p><b>Ex:</b> For track 20, press +10 then 10.</p>	<ol style="list-style-type: none"> <li>1. The <b>DISC</b> button will allow you to choose the disc where the track you want to listen to is loaded.</li> <li>2. The selected track starts playing.</li> </ol>

## To Change Discs While Playing

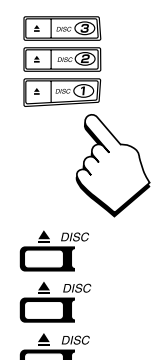

You can replace a CD in a tray not being used, while another CD is playing.

Unit/Remote Control	Steps	Explanation/Remarks
	<p><b>On the Unit/Remote Control</b></p> <ol style="list-style-type: none"> <li>1. Press the <b>(▲)</b> button of the tray not being used.</li> <li>2. Press the <b>(▲)</b> button to close the tray.</li> </ol>	<ol style="list-style-type: none"> <li>1. The tray opens and replace the disc in the tray.</li> </ol>

# Programming the Playing Order of the Tracks



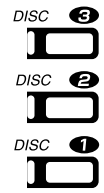
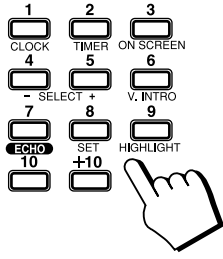

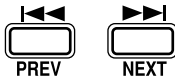
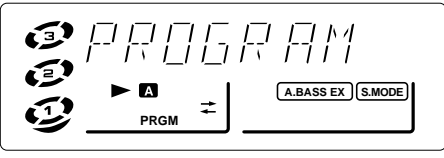
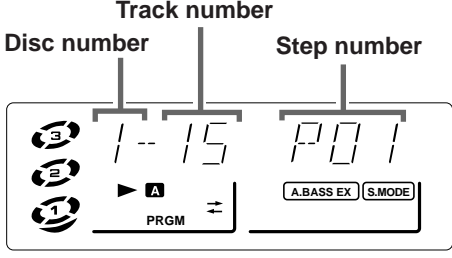
You can change the order in which the discs and tracks play, and select only the discs and tracks you want from among those loaded in the CD Player.

- You can program up to 32 steps in any desired order from among the discs in the player.
- You can only make a program when the CD Player is stopped.
- You need to use the Remote Control to handle this function.

Remote Control	Steps	Explanation/Remarks
<p><b>1</b></p>  <p><b>2</b></p>  <p><b>3</b></p>  <p><b>5</b></p>  <p><b>6</b></p> 	<p><b>On the Remote control</b></p> <ol style="list-style-type: none"> <li>1. Press the <b>PLAY MODE</b> button to select “PROGRAM”.</li> <li>2. Select a disc with the <b>DISC (1-3)</b> buttons.</li> <li>3. Press the number keys to select the track to program. <b>Ex:</b> For track 15, press +10 then 5. For track 20, press +10 then 10.</li> <li>4. Repeat steps 2 to 3 to select other tracks.</li> <li>5. Press the (▶) <b>SELECT</b> button to play.</li> <li>6. Press the (◀◀) <b>PREV</b> or (▶▶) <b>NEXT</b> button to skip to a particular programmed track.</li> </ol> <p>To Stop playing: Press the (⏪) <b>RETURN</b> (■) button.</p> <p>To Delete the program: Press the (⏪) <b>RETURN</b> (■) button again.</p> <p>To Cancel the Program Play Mode:</p> <ul style="list-style-type: none"> <li>• Press the (⏪) <b>RETURN</b> (■) button again after deletion.</li> </ul> <p><b>OR</b></p> <ul style="list-style-type: none"> <li>• Press the <b>PLAY MODE</b> button. The Program Play Mode is canceled and another play mode will be selected.</li> </ul> <p>To Repeat :</p> <p>Press the <b>REPEAT</b> button to repeat the programmed tracks over and over again. (See page 20)</p>	<ol style="list-style-type: none"> <li>1. The display changes with each press of the <b>PLAY MODE</b> button as shown below : → <b>PROGRAM</b> → <b>RANDOM</b> → No play mode indication → (back to beginning) • The “PRGM” play mode indicator lights up. • If a program is already in progress, the last step of the program is displayed.</li> </ol>  <ol style="list-style-type: none"> <li>2. When a disc is selected through the <b>DISC</b> buttons, the display changes to the Program Entry display.</li> </ol>  <p style="text-align: center;">Track number Disc number      Step number</p> <ol style="list-style-type: none"> <li>3. Once the (▶) <b>SELECT</b> is pressed, the Unit plays the tracks in the order you have programmed them.</li> <li>4. When you try to program a track number not existing on a CD: <ul style="list-style-type: none"> <li>• If the target disc has been selected as the source CD, you cannot program a number not existing on the CD. Such an entry will be ignored while programming.</li> <li>• If the target disc has not been selected as the source CD, you can program a number (up to 99) even if it does not exist on the CD. However such entries will be skipped and removed during Program Play.</li> </ul> </li> <li>5. When the <b>REPEAT</b> button is pressed, the Repeat mode indicators light up with each press of the <b>REPEAT</b> button (refer page 20).</li> </ol>











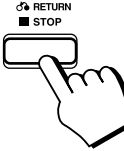



## Repeating a Selection or the Discs

You can have all the discs, the program or the individual selection currently playing repeat as many times as you like.

Unit	Steps	Explanation/Remarks
<p><b>REPEAT</b></p> 	<p><b>On the Unit</b></p> <ol style="list-style-type: none"> <li>1. Press the <b>REPEAT</b> button.</li> <li>2. To exit <b>REPEAT MODE</b>, press thge <b>REPEAT</b> button repeatedly until the Repeat mode indicator goes out.</li> </ol>	<ol style="list-style-type: none"> <li>1. The display changes with each press of the button, as shown below :  →  →  <b>ALL</b> → No indication → (back to the beginning)   : Repeats one track on a CD.   <b>ALL</b>: Repeats all the tracks on all the CDs in the CD Player.</li> <li>2. For Video CDs, use Video CDs without the PBC function for <b>Repeat Mode</b>. (See page 23).</li> </ol>

## Random Play

The tracks will play in no special order when you use this mode.

Unit	Steps	Explanation/Remarks
<p><b>1</b></p> <p><b>RANDOM</b></p>  <p><b>2</b></p>  <p><b>1</b></p> <p><b>PLAY MODE</b></p>  <p><b>2</b></p> <p><b>SELECT</b></p>  <p><b>3</b></p> <p><b>PREV</b></p>  <p><b>4</b></p> <p><b>NEXT</b></p>  <p><b>RETURN</b></p>  <p><b>REPEAT</b></p> 	<p><b>On the Unit</b></p> <ol style="list-style-type: none"> <li>1. Press the <b>RANDOM</b> button while the CD player is stopped.</li> <li>2. To Cancel, press (  ) <b>RETURN</b> (  ) <b>STOP</b> while the CD player is stopped. Continuous play is resumed.</li> </ol> <p><b>On the Remote Control</b></p> <ol style="list-style-type: none"> <li>1. Press the <b>PLAY MODE</b> button while the CD Player is stopped, to select "RANDOM".</li> <li>2. Press the (  ) <b>SELECT</b> button to start Random play.</li> <li>3. Press the (  ) <b>PREV</b> to jump to the start of the track being played. Press the (  ) <b>NEXT</b> button to skip to the next track with each press of the button. <ul style="list-style-type: none"> <li>• You can also operate with the similar buttons on the Unit.</li> </ul> </li> <li>4. To Cancel, press (  ) <b>RETURN</b> (  ) while the CD player is stopped to select a different Play Mode. Press <b>REPEAT</b> button before or during random play to instruct the System to continue with a different random selection after the last selection is played.</li> </ol>	<ol style="list-style-type: none"> <li>1. When <b>RANDOM</b> button is pressed on the Unit, <ul style="list-style-type: none"> <li>• <b>RANDOM</b> indicator lights up.</li> <li>• Playback starts.</li> </ul> </li> <li>2. When the Remote Control is used, the display changes with each press of the <b>PLAY MODE</b> button :  → <b>PROGRAM</b> → <b>RANDOM</b> → No play mode indication → (back to the beginning)</li> <li>3. When Random Mode is canceled, the <b>RANDOM</b> indicator goes out.</li> <li>4. Random play cannot be activated with the <b>DISC</b> (1-3) button.</li> </ol>



# Tray Lock Function

In order to keep the discs in the CD Player safely, the disc trays can be locked electronically in a single operation.

When the electronic lock is on, the trays cannot be opened even if the (▲) button is pressed. This function can only be operated by using the buttons on the Unit itself.

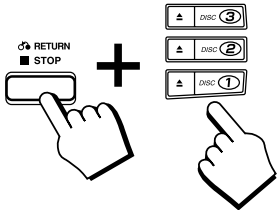
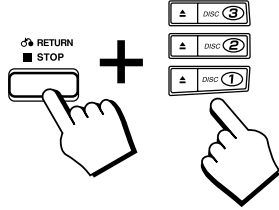
Unit	Steps	Explanation/Remarks
	<p><b>Locking the Electronic Lock On the Unit</b></p> <ol style="list-style-type: none"> <li>1. Put the System's power into <b>STANDBY</b> mode.</li> <li>2. While pressing the (◻) <b>RETURN (■) STOP</b> button, press the (▲) button for <b>DISC 1</b>'s tray on the Unit.</li> </ol>	<ol style="list-style-type: none"> <li>1. "<b>LOCKED</b>" appears on the display. The trays are now locked.</li> </ol> <p style="text-align: center; font-family: monospace; font-size: 1.2em;">L O C K E D</p> <ol style="list-style-type: none"> <li>2. Pressing the (▲) buttons will not open the trays. The display shows the message "<b>LOCKED</b>".</li> <li>3. (▲) button cannot be used to automatically turn on the power.</li> <li>4. You can still play the CD, cassette or tune to a radio station.</li> </ol>
	<p><b>Unlocking the Electronic Lock On the Unit</b></p> <ol style="list-style-type: none"> <li>1. Put the System's power into <b>STANDBY</b> mode.</li> <li>2. While pressing the (◻) <b>RETURN (■) STOP</b> button, press the (▲) button for <b>DISC 1</b>'s tray on the Unit.</li> </ol>	<ol style="list-style-type: none"> <li>1. "<b>UNLOCKED</b>" appears on the display. The trays are now unlocked.</li> </ol> <p style="text-align: center; font-family: monospace; font-size: 1.2em;">U N L O C K E D</p> <ol style="list-style-type: none"> <li>2. You can now open the trays by pressing the (▲) buttons.</li> <li>3. (▲) button can now also be used to automatically turn on the power.</li> </ol>

# Operation Of Playback Control Function

## Playing Video CDs with Playback Control Function

This System provides a Playback Control function which utilizes a procedure (menu selection) programmed in a Video CD. The playback operation procedure may differ depending on the disc you use. Video CD with the Playback Control Function is required.

The Playback Control function is described below and in the figure on the next page.

- **High-resolution still image display** : Super-fine reproduction of still images with more than 4 times the resolution of video tape.
- **Menu-driven playback** : interactive menus for easy selection of tracks.

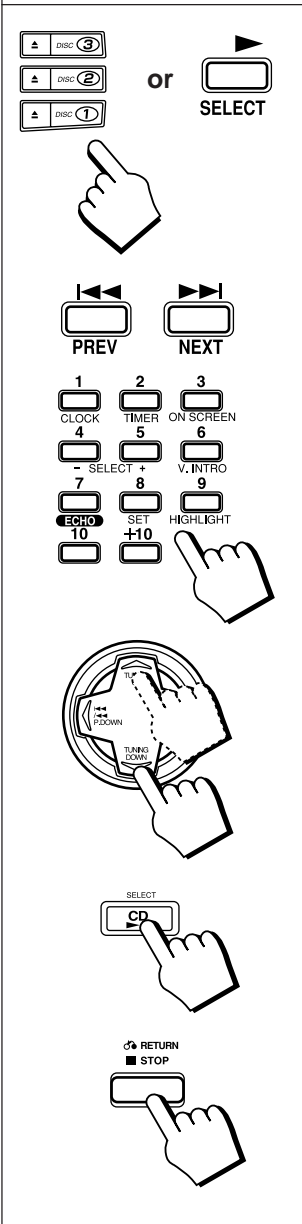
Unit/Remote Control	Steps	Explanation/Remarks
 <p>The diagram illustrates the physical controls for the Playback Control Function. It shows three buttons labeled 'DISC 1', 'DISC 2', and 'DISC 3' with arrows pointing to them. To the right is a 'SELECT CD' button with a play/pause symbol. Below these are 'PREV' and 'NEXT' buttons with left and right arrows. A numeric keypad with buttons 1 through 10 is shown, with a hand pointing to the '1' button. Below the keypad are 'ECHO', 'SET', and 'HIGHLIGHT' buttons. At the bottom are 'RETURN' and 'STOP' buttons. A hand is also shown pointing to a 'SELECT CD' button on a remote control.</p>	<p><b>On the Unit/Remote Control</b></p> <ol style="list-style-type: none"> <li>1. Press the <b>DISC (1-3)</b> or <b>SELECT CD (▶/  )</b> button.</li> <li>2. Press the <b>(◀◀) PREV</b> or <b>(▶▶) NEXT</b> to move through the next menus.</li> <li>3. <b>On the Remote Control:</b> Select an item in the menu by pressing the number keys (See page 15). Your selection will start.</li> </ol> <p><b>On the Unit:</b> Press the <b>VCD NUMBER [TUNING UP or TUNING DOWN]</b> on the <b>MULTI CONTROL</b>. Then press the <b>SELECT CD (▶/  )</b> button to start playing the disc. <ol style="list-style-type: none"> <li>4. Press the <b>(⏪) RETURN (■) STOP</b> to stop the track being played and return to a menu. Press the button for 2 seconds and the disc will stop playing. A blue screen appears on the TV.</li> </ol> </p>	<ol style="list-style-type: none"> <li>1. The Player starts up the PBC function. "PBC" is shown on the Display.</li> <li>2. When there is only one menu, pressing <b>(▶▶) NEXT</b> will start the disc.</li> </ol>

# What is the Playback Control PBC function?

The Playback Control function, PBC allows you to enjoy menu-driven operation and high resolution still images having a resolution four times greater than video pictures.

- **Menu-driven playback**

You can interact with the screen using a menu display to select and play an entry.

- **High-resolution still image display**

You can display high-quality images four times clearer than video pictures.

### Playing a Video CD with the PBC function without using menu screen.

Even if a Video CD has the PBC function, you can cancel the PBC function and play the disc without using menu screen, as if it were without the PBC function.

- Choose either “(↶)” or “(↶) ALL”, then press the **DISC (1-3)** to select the disc.

You can play a Video CD from track 1 without using menu screen.

OR

- Press the number button of the track you want to start during the blue screen appears on the TV screen. For example, to start from the beginning, press 1.

**To stop during play and restore the PBC function, press the (⏮) RETURN (■) STOP.** If you try to start playing again, the PBC function for the Video CD is restored.

**Note:** After canceling the PBC function, you can enjoy Continuous Play of more than one Video CD with the PBC function.

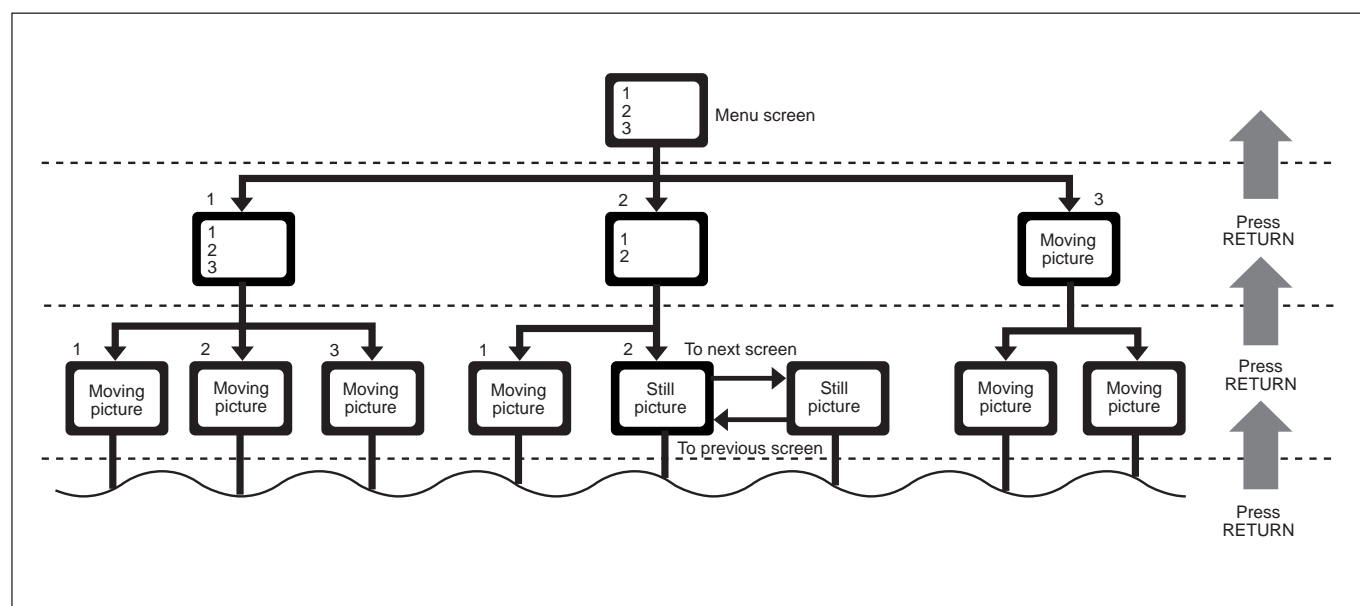

A selection menu is displayed when you start playing a Video CD with the Playback Control function. The selection menu shows a list of number for selection. Some disc may show moving pictures or a divided screen.

1. When a list of number is displayed, selecting a number shows its contents.
2. When a moving pictures is displayed, pressing (▶) **SELECT** at the time when a part of the movie you desire is shown plays the movie.
3. When the selection menu is redisplayed after you have played your selection, selecting a number again can reply its contents. (Some discs may show the menu screen several times)

When (▶▶) **P.UP [NEXT]** and (◀◀) **P.DOWN [PREV]** are shown, pressing (▶▶) **P.UP [NEXT]** and (◀◀) **P.DOWN [PREV]** can changed the selection menu.

4. After playback, press (⏮) **RETURN (■) STOP** to go back to the previous screen.  
After playback, pressing (⏮) **RETURN (■) STOP** for 2 seconds or more causes it to stop. Some discs may return you to the menu screen shown before playback.

Notes:

- When a menu is displayed for a long time, about 10 minutes, the screen background automatically fades out to prevent screen burn-in while the setting is suspended.
- When using the **REPEAT** function, the PBC function is not available,

# Graphic CDs

## Playing Graphic CDs

### 1) Playing back a CD-G

Basic CD-playing procedures (described on pages 17-20) can also apply to the CD-G playback.

When you start playing a CD-G, “**GRAPHICS**” appears on the display.

To use a CD-G as a Karaoke source, see page 37.

### 2) Playing back a Video CD without the PBC function

Basic CD-playing procedures (described on pages 17-20) can also apply to the playback of Video CDs without the PBC function.

When you start playing a Video CD without the PBC function, “**VIDEO CD**” appears on the display. To use a Video CD without the PBC function as a Karaoke source, see page 38.

#### Notes :

1. The following operations may distort the image on the TV screen.
  - Searching for beginning points of the track
  - Fast forwarding/reversing the track
  - Stop/pause
  - Frame-by-frame playback
2. If paused for more than 10 minutes, the still image disappears from the display.

# Various Unique Functions

## Various Functions to Enhance Your Enjoyment

The following functions can only be executed with the buttons on the Remote Control.

### Frame-by-Frame Playback

You can advance a still picture frame by frame.

Frame-by-Frame Playback is only possible when the moving pictures (of the Video CDs with or without the PBC function) are played back.

Remote Control	Steps	Explanation/Remarks
	<p><b>On the Remote Control</b></p> <ol style="list-style-type: none"> <li>1. Press the <b>(  ) STILL</b> button.</li> </ol>	<ol style="list-style-type: none"> <li>1. You will see the still picture on the TV when you press the button once. Then each time you press the button, the picture advances by one frame.</li> <li>2. During this function, you will hear no sound.</li> </ol>

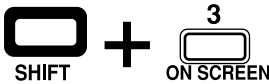

### Display of Operating Status

Using this function, you can watch the operating status on the TV screen.

Remote Control	Steps	Explanation/Remarks
	<p><b>On the Remote Control</b></p> <ol style="list-style-type: none"> <li>1. Press the <b>ON SCREEN</b> button while pressing the <b>SHIFT</b> button.</li> <li>2. To display disc number, track number and playing time always on the screen, press the <b>ON SCREEN</b> button repeatedly while pressing the <b>SHIFT</b> button.</li> </ol>	<ol style="list-style-type: none"> <li>1. The TV screen will show the below :           <div data-bbox="992 1149 1255 1339" style="border: 1px solid black; padding: 10px; margin: 10px auto; width: fit-content;"> <p style="text-align: center;">NORMAL REPEAT ECHO KEY ▶.....▶.....#</p> </div> </li> <li>2. Each time you press the button, the display mode switches On and Off ( <b>DISP. OFF</b> ).</li> <li>3. When the display mode is on, disc number, track number and playing time will always be shown on the screen.</li> </ol>

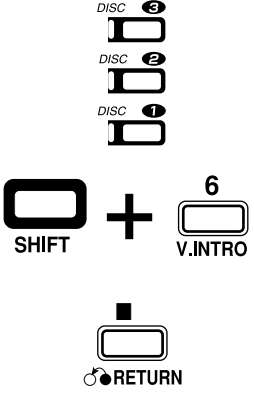

## Viewing the Video Intro of a Video CD

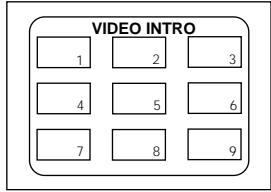
Using this function, you can check the contents of a Video CD, watching first 5 seconds of each track on the Video CD.

Remote Control	Steps	Explanation/Remarks
	<p><b>On the Remote Control</b></p> <ol style="list-style-type: none"> <li>1. Press the <b>DISC (1-3)</b> button for the disc you want to check out.</li> <li>2. Press the <b>V.INTRO</b> button while pressing the <b>SHIFT</b> button after a picture appears on the TV screen.</li> <li>3. To Select a track during V.INTRO Play, press the number key for the track.</li> <li>4. To Stop and Cancel the V.INTRO Play, press the (  ) <b>RETURN (■)</b> button.</li> </ol>	<ol style="list-style-type: none"> <li>1. Playback begins. <ul style="list-style-type: none"> <li>• For Video CD with PBC, follow steps 1 to 3 on page 23.</li> </ul> </li> <li>2. The Video Intro Play starts and shows in sequence, the first 5 seconds of nine tracks on the display. If the CD consists of more than 9 tracks, tracks above 9 will be shown after the first 9 tracks are shown. <div data-bbox="995 560 1262 750" style="text-align: center;">  </div> </li> <li>3. When a track is selected, the Video Intro Play will be canceled and the Continuous Play starts from the selected track.</li> </ol>

## Viewing the Highlights of a Video CD

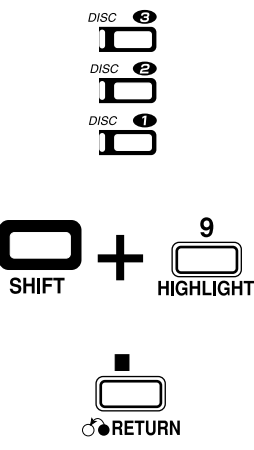
Using this function, you can watch nine highlight scenes of the selected track on a Video CD. These highlight scenes are created by dividing the track equally into nine portions and the beginning (5 seconds each) of those nine scenes are shown on the display.

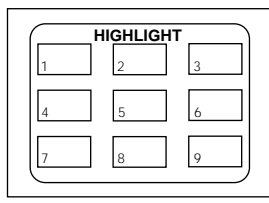
Remote Control	Steps	Explanation/Remarks
	<p><b>On the Remote Control</b></p> <ol style="list-style-type: none"> <li>1. Press the <b>DISC (1-3)</b> button and the number key for the track you want to watch the highlights of.</li> <li>2. Press the <b>HIGHLIGHT</b> button while pressing the <b>SHIFT</b> button after a picture appears on the TV screen.</li> <li>3. To Select a track while viewing the highlights, press the number key for the highlight scene.</li> <li>4. To Stop and Cancel the HIGHLIGHT Play, press the (  ) <b>RETURN (■)</b> button.</li> </ol>	<ol style="list-style-type: none"> <li>1. Playback begins. <ul style="list-style-type: none"> <li>• For Video CD with PBC, follow steps 1 to 3 on page 23.</li> </ul> </li> <li>2. The Highlight Play starts and shows in sequence, the first 5 seconds of nine divided highlight scenes on the display for 1 minute. If a highlight scene is not selected, it will automatically start and show Highlight of the next track every one minute. <div data-bbox="1027 1400 1293 1601" style="text-align: center;">  </div> </li> <li>3. When a highlight scene is selected, the Highlight Play will be cancelled and Continuous Play starts from the selected track.</li> <li>4. If a highlight scene is not selected while 9 scenes are shown on the TV, nine highlight scene of the next track will appear on the display.</li> </ol>

### Notes:

When a highlight scene is selected, playback starts from the beginning of the highlight scene, but not from the still image shown on the display (the part shown is the last part of the highlight scene, not its beginning).

During the Video Intro or Highlight Plays, image shown on the display may be partially distorted, resulting from noises or incorrect manufacturing of the disc.

# Using the Cassette Deck (Listening to a Tape)

## Unit (Front Panel)

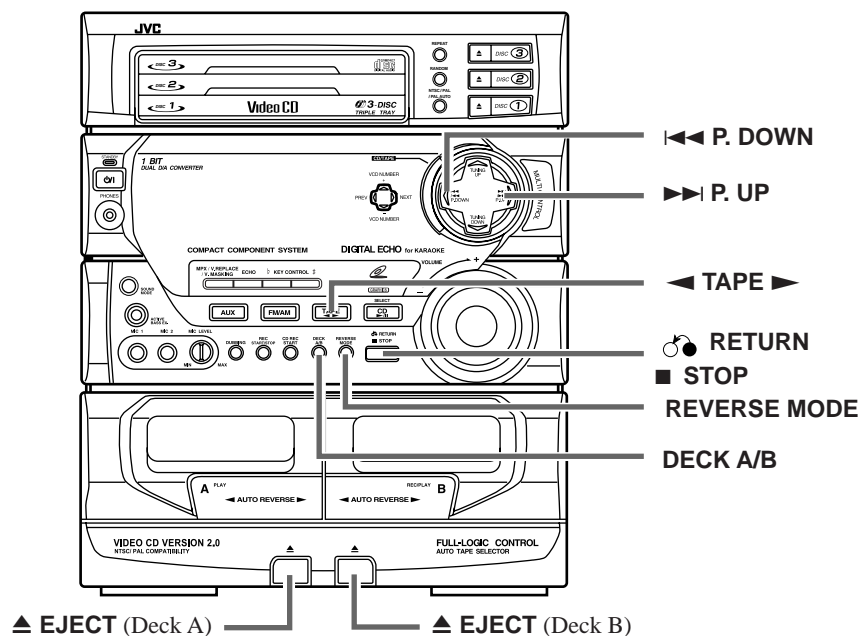

## Remote Control

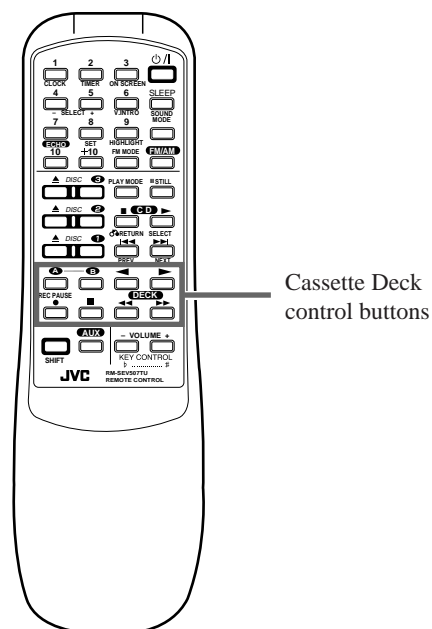

## Display



◀▶ : Tape Direction indicator

**A B** : Deck A, B indicator

◀▶ : Reverse Mode indicator

When the System is being used, the display shows other items as well. However, we have only shown the items described in this section.

### Tape Direction Indicator on the Display

- The Tape Direction indicator tells you which direction the selected tape deck will use for the playback.
- During playback, the direction indicator blinks slowly.
- During fast left or fast right, the indicator blinks quickly.
- During Music Scan mode, the direction indicator alternates between blinking slowly and quickly repeatedly.

The Cassette Deck allow you to play, record and dub audio tapes.

With Automatic Tape Detection, you can listen to Type I, II and IV tapes without changing any settings







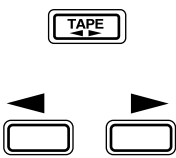

### Caution:

The use of tapes longer than 120 minutes is not recommended, since characteristics deterioration may occur and these tapes easily jam in the pinch-rollers and the capstans.

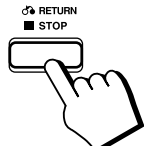
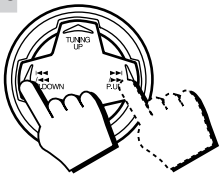
## One Touch Play

Unit/Remote Control	Steps	Explanation/Remarks
	<p><b>On the Unit</b></p> <ol style="list-style-type: none"> <li>1. Press the (◀) <b>TAPE</b> (▶) button.</li> </ol> <p><b>On the Remote Control</b></p> <ol style="list-style-type: none"> <li>1. Press the (◀) or (▶) button.</li> </ol>	<ol style="list-style-type: none"> <li>1. The unit will turn on and if there is a tape in the deck, it will start to play. If no tape is loaded, the Unit will come on and wait for you to insert a tape, or select another function.</li> <li>2. "TAPE" will appear on the Display.</li> </ol>

## Regular Play

Unit/Remote Control	Steps	Explanation/Remarks
<p><b>2</b></p>  <p><b>5</b></p>  <p><b>6</b></p>  <p><b>7</b></p>  <p><b>9, 10</b></p>  <p><b>11</b></p>  <p><b>2</b></p>  <p><b>3</b></p>  <p><b>5</b></p>  <p><b>6</b></p> 	<p><b>On the Unit</b></p> <ol style="list-style-type: none"> <li>1. Turn the power on.</li> <li>2. Press the (▲) eject button for the deck you want to use.</li> <li>3. When the deck is opened, put the cassette in, with the exposed part of the tape down towards the base of the deck. <ul style="list-style-type: none"> <li>• If the cassette holder does not open, turn the Unit off, then back on and press the (▲) eject button again.</li> </ul> </li> <li>4. Close the holder gently. <ul style="list-style-type: none"> <li>• If both deck contains a tape, the last deck inserted with tape is selected.</li> </ul> </li> <li>5. To change the selected deck, press the <b>DECK A/B</b> button.</li> <li>6. To Play, press the (◀) <b>TAPE</b> (▶) button. The tape starts to play towards the direction selected.</li> <li>7. To Stop, press the (⏪) <b>RETURN</b> (■) <b>STOP</b> button.</li> <li>8. To Change deck while playing, press the (◀) <b>TAPE</b> (▶) button after pressing the <b>DECK A/B</b> button.</li> <li>9. To Rewind, press the (◀◀) <b>P.DOWN</b> [PREV] while the tape is stopped.</li> <li>10. To Fast Forward, press the (▶▶) <b>P.UP</b> [NEXT] while the tape is stopped.</li> <li>11. To Remove the tape, stop the tape and press the (▲) eject button.</li> </ol> <p><b>On the Remote Control</b></p> <ol style="list-style-type: none"> <li>1. Press the <b>A</b> or <b>B</b> button to select the deck.</li> <li>2. To Play, press the (◀) or (▶) button.</li> <li>3. To Stop, press the (■) button.</li> <li>4. To Change deck while playing, press <b>A</b> or <b>B</b> button before pressing the (◀) or (▶) button.</li> <li>5. To Rewind, press the (◀◀) button.</li> <li>6. To Fast Forward, press the (▶▶) button.</li> </ol>	<ol style="list-style-type: none"> <li>1. When in the Rewind mode, the tape will wind towards the left side of the tape.</li> <li>2. When in the Fast Forward mode, the tape will wind towards the right side of the tape.</li> <li>3. <b>Note :</b> Deck A and Deck B cannot playback at the same time.</li> </ol>



## Music Scan

To find the beginning of a music track during play, use the Music Scan function. Music Scan searches for blank portions that usually separate selections, then plays the next selection.

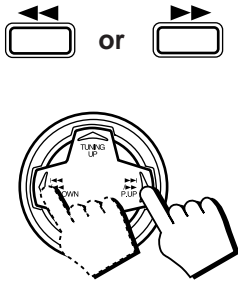
Unit/Remote Control	Steps	Explanation/Remarks
	<p><b>To Find the Beginning of the Current Selection</b></p> <ol style="list-style-type: none"> <li>1. Press the ◀◀ or ▶▶ or (◀◀ or ▶▶ button on the Remote Control) in the opposite direction to that in which the tape is playing.</li> </ol> <p><b>To Find the Beginning of the Next Selection</b></p> <ol style="list-style-type: none"> <li>1. Press the ◀◀ or ▶▶ or (◀◀ or ▶▶ button on the Remote Control) in the same direction to that in which the tape is playing.</li> </ol>	<ol style="list-style-type: none"> <li>1. Searching stops at the beginning of the current selection, and the current selection starts automatically.</li> </ol> <ol style="list-style-type: none"> <li>1. Searching stops at the beginning of the next selection, and the next selection starts automatically.</li> </ol> <div style="border: 1px solid black; padding: 5px; margin-top: 10px;"> <p><b>Notes:</b>            Music scan works by detecting a 4-second long blank at the beginning of each selection, so it won't work well if your tape has:</p> <ul style="list-style-type: none"> <li>• No blank at the beginning of a selection.</li> <li>• Noise (tape often used or poor dubbing) which fills the blank with noise.</li> <li>• Long, very soft passages or pauses in a selection. The scan will detect these as 4-second long blanks. If this happens, scan again.</li> </ul> </div>

## Reverse Mode

You can play both sides of a cassette, or play both the tapes in the two decks continuously.

Unit	Steps	Explanation/Remarks
<p><b>REVERSE MODE</b></p> 	<p><b>On the Unit</b></p> <ol style="list-style-type: none"> <li>1. Press the <b>REVERSE MODE</b>.</li> <li>2. To change the Reverse Mode, press the <b>REVERSE MODE</b> again.</li> </ol>	<ol style="list-style-type: none"> <li>1. The indicator changes with each press of the button.           <ul style="list-style-type: none"> <li>→ (↔) → (↔) → (↔) → (back to the beginning)</li> <li>• (↔) : the deck stops after playing one side of the tape.</li> <li>• (↔) : the deck stops after playing both side of the tape.</li> <li>• (↔) : After playing both sides on the tape, the Unit will play the other tape; if there is a tape in the other deck. The tapes will play continuously over and over again until it is stopped.</li> </ul> </li> </ol>

# Using the Cassette Deck (Recording)

## Unit (Front Panel)

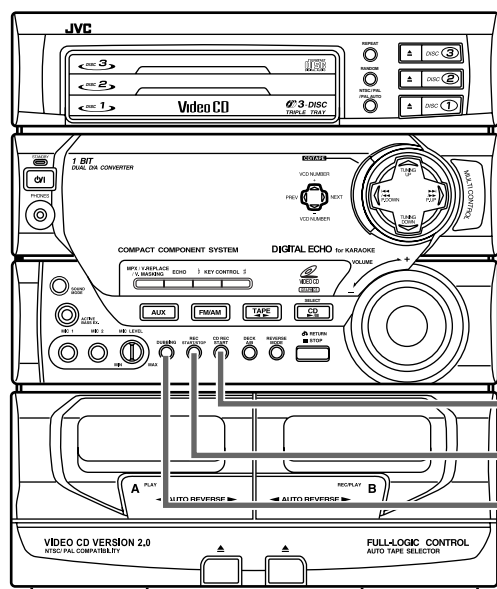

CD REC START

REC START/STOP

DUBBING

## Remote Control

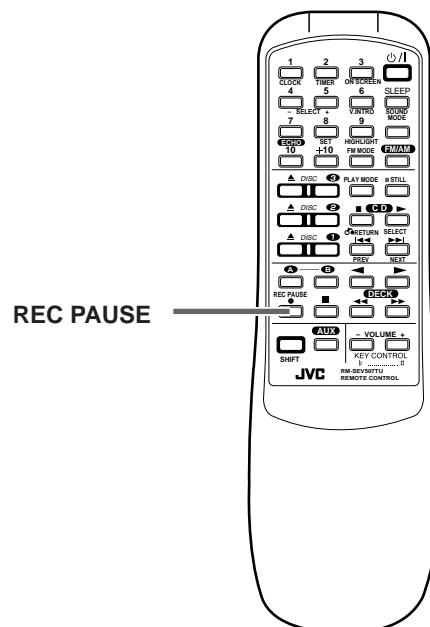

REC PAUSE

## Display

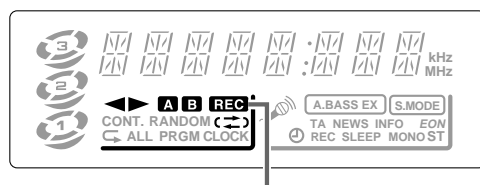

REC indicator

When the System is being used, the display shows other items as well. However, we have only shown the items described in this section.

Recording onto a cassette from any kind of the audio sources is simple. Just insert a cassette in Deck B, have the source ready, make one or two settings, and you're ready to record.

## Things To Know Before You Start Recording

- It may be unlawful to record or playback copyright material without the consent of the copyright owner.
- When you want to record onto both sides of a tape, you can set the Reverse mode on to do so. However, recording automatically stops after recording in the (◀) direction in Reverse mode. Therefore, make sure that the tape direction is (▶) when recording with Reverse mode on.
- The recording level, which is the volume at which the new tape is being made, is automatically set correctly, so it is not affected by the **VOLUME** control on the System. Thus during recording you can adjust the sound you are actually listening to without affecting the recording level.
- Two small tabs on the back of the cassette tape, one side for side A and one for side B, can be removed to prevent accidental erasure or re-recording. To record on a cassette with the tabs removed, you must cover the holes with adhesive tape first. However when a Type II tape is used, only cover part of the hole as shown, since the other part of the hole is used to detect the tape type.
- When recording, you can hear Sound Mode effects through the speakers or headphones. However, sound is recorded without Sound Mode effects.
- Only Type I and Type II tapes can be used for recording.

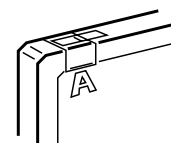









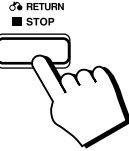

**Note:** At the start and end of tapes, there is leader tape which cannot be recorded onto. Depending on the recording source, the first part of the recording may be missing because of the leader. When recording CDs or radio broadcasts, first wind on the leader tape before recording.

**Caution:** If recordings you have made have excessive noise or static, the Unit may be too close to a TV which was on during the recording. Either turn off the TV or move the System away from the TV.

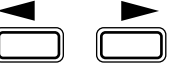
# Standard Recording

This is the basic method for recording. You can record from a tape in Deck A, a CD, the Tuner or Auxiliary source. Insert a tape into Deck B to be recorded. Only Deck B can record.

Unit/Remote Control	Steps	Explanation/Remarks
<p><b>2</b></p> <p><b>REVERSE MODE</b></p>  <p><b>3</b></p> <p><b>TAPE</b></p>  <p><b>RETURN</b> <b>STOP</b></p>  <p><b>5</b></p> <p><b>REC START/STOP</b></p> 	<p><b>On the Unit</b></p> <ol style="list-style-type: none"> <li>1. Insert a blank or erasable tape into Deck B.</li> <li>2. Press the <b>REVERSE MODE</b> button if you want to record on both sides of the tape. Press until the (↔) or (↔) indicator lights up on the display.</li> <li>3. Check the recording direction for the tape. If you want to change the tape direction, press (↶) <b>RETURN</b> (■) <b>STOP</b> button after pressing the (↶) <b>TAPE</b> (↷) button.</li> <li>4. Prepare the source by inserting a tape into Deck A, playing CDs, tuning in a radio station or turning on the connected equipment.</li> <li>5. Press the <b>REC START/STOP</b> button to start recording. Use this button also if the recording is Paused.</li> <li>6. To Stop recording, press <b>REC START/STOP</b> button.</li> </ol>	<ol style="list-style-type: none"> <li>1. Make sure the tapes are of Type I or II. Their tabs must not be opened.</li> <li>2. When using the Reverse Mode, ensure the tape to be recorded will be recorded in the forwards (▶) direction.</li> <li>3. When <b>REC START/STOP</b> or <b>REC PAUSE</b> (●) button is pressed, the <b>REC</b> indicator will lit on the display.</li> </ol> <p><b>Note:</b> When recording in the Reverse Mode, the System automatically stops when it reached the end of the reverse (↶) direction. To record on both sides of a tape, make sure that the recording direction for the tape inserted into Deck B is forwards (▶). The tape indicator should also be in the forwards (▶) direction before you start recording.</p>
<p><b>3</b></p>  <p><b>5</b></p> <p><b>REC PAUSE</b></p>  <p><b>6</b></p>  <p><b>7</b></p> <p><b>REC PAUSE</b></p>  <p><b>8</b></p>  <p><b>9</b></p> 	<p><b>On the Remote Control</b></p> <ol style="list-style-type: none"> <li>1. Insert a blank or erasable tape into Deck B on the unit.</li> <li>2. Press the <b>REVERSE MODE</b> button on the unit if you want to record on both sides of the tape.</li> <li>3. Check the recording direction for the tape. If you want to change the tape direction, press (■) button after pressing the (↶) <b>TAPE</b> (↷) button.</li> <li>4. Prepare the source by inserting a tape into Deck A, playing CDs, tuning in a radio station or turning on the connected equipment.</li> <li>5. Press the <b>REC PAUSE</b> (●) button.</li> <li>6. To start, press the (↶) or (↷) button. Recording starts in the direction pressed. When using Reverse Mode to record both sides of a tape, press the (↷) button.</li> <li>7. To Pause at any one time of the recording, press the <b>REC PAUSE</b> (●) button.</li> <li>8. To Restart, press the (↶) or (↷) button (for the same direction as the tape was running) (If using the Unit, press REC START/STOP button)</li> <li>9. To Stop recording, press (■).</li> </ol>	



## To reduce the beat during recording AM station

When recording an AM broadcast, beats may be produced which are not heard when listening to the broadcast. In this case, press the REPEAT button on the CD Player to eliminate the beats.

Unit	Steps	Explanation/Remarks
<p><b>REPEAT</b></p> 	<p><b>On the Unit</b></p> <ol style="list-style-type: none"> <li>Set to AM station and start recording.</li> <li>Press the <b>REPEAT</b> button repeatedly until the beats are eliminated.</li> </ol>	<ol style="list-style-type: none"> <li>Pressing the <b>REPEAT</b> button repeatedly will cancel off the unwanted beats. The display changes as below :  <b>→ CUT 1 → CUT 2 → CUT 3 →</b> (back to the beginning)            If the proper setting is selected, the beats will be eliminated.</li> </ol>

## CD Direct Recording

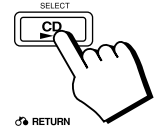



The order of recording of the tracks goes according to the original order of the CD or to the order you have programmed. The CD player starts playing automatically and recording begins. When the CD player finishes playing, recording will stop automatically.

Unit	Steps	Explanation/Remarks
<p><b>3</b></p>  <p><b>4</b></p>  <p><b>CD REC START</b></p> 	<p><b>On the Unit</b></p> <ol style="list-style-type: none"> <li>Prepare CDs. (See page 16)</li> <li>Insert a cassette in Deck B to record on. Refer to page 31 for Reverse Mode recording.</li> <li>Press the <b>SELECT CD (▶/  )</b>, then <b>(⏪) RETURN (■) STOP</b> button.</li> <li>Press the <b>CD REC START</b> button.</li> </ol>	<ol style="list-style-type: none"> <li>When recording begins, the <b>REC</b> indicator lights up.</li> <li>If recording is made on the <b>Reverse Mode</b>, the Unit will continue recording the last song at the end of the first side on the beginning of the next side.</li> <li>If <b>SLEEP</b> timer is used during recording, please make sure that the time set is more than enough for the recording to complete. Otherwise the recording will terminate midway.</li> <li>To Stop recording, press <b>(⏪) RETURN (■) STOP</b> button or <b>REC START/STOP</b>.</li> </ol>

## Tape to Tape Recording (Dubbing)

Dubbing is termed as the recording from Deck A to Deck B. Tapes can be dubbed by just pressing a single button.

- The playback direction of Deck A and Deck B has to be the same.
- It is preferable that the type of tape used for recording is the same as the type (Type I or Type II) you want to record from.

Unit	Steps	Explanation/Remarks
<p><b>3</b></p>  <p><b>4</b></p>  <p><b>DUBBING</b></p>  <p><b>REC START/STOP</b></p> 	<p><b>On the Unit</b></p> <ol style="list-style-type: none"> <li>Insert the source tape into Deck A for playback.</li> <li>Insert the blank or erasable tape into Deck B for recording.</li> <li>Press the <b>(◀) TAPE (▶)</b> button and then <b>(⏪) RETURN (■) STOP</b> button.</li> <li>Press the <b>DUBBING</b> button. To Stop dubbing, press the <b>(⏪) RETURN (■) STOP</b> button or <b>REC START/STOP</b> button.</li> </ol>	<ol style="list-style-type: none"> <li>Ensure the tape will be played in the <b>(▶)</b> direction.</li> <li>Ensure the tape will be recorded in the <b>(▶)</b> direction.</li> <li>When dubbing begins, Deck A and Deck B will start simultaneously.</li> <li>During dubbing, Sound Mode effects can be heard through the speakers/headphones but will not be dubbed.</li> </ol>

# Using the Timer

Unit (Front Panel)

Display

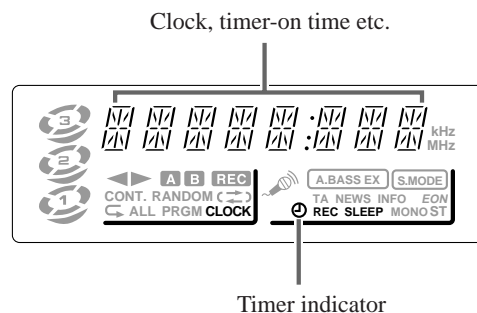
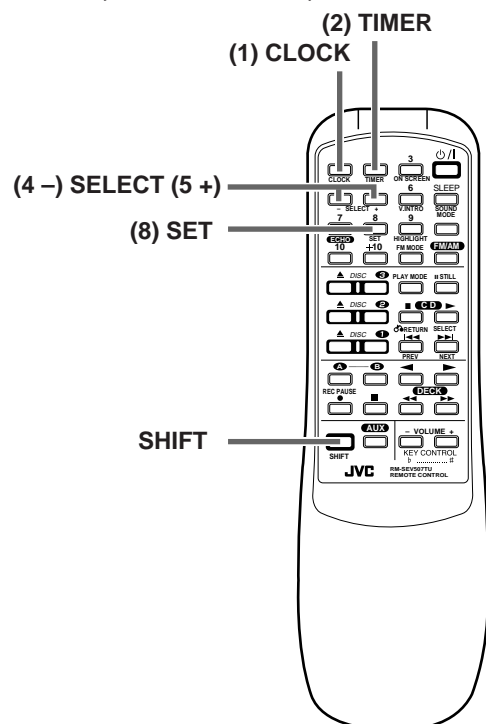

When the System is being used, the display shows other items as well. However, we have only shown the items described in this section.

The timers let you control listening and recording functions automatically.

Use the **Remote Control** to set the clock and timers. The clock can be set whether the Unit is on or off.

**The clock must be set before the timers can work.**





















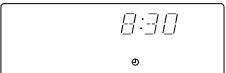

## Setting the Clock

Remote Control	Steps	Explanation/Remarks
<p><b>1</b></p> <p>SHIFT</p>	<p><b>On the Remote Control</b></p> <ol style="list-style-type: none"> <li>1. Press and hold the <b>SHIFT</b> button until the following procedure is finished.</li> <li>2. Press the <b>CLOCK</b> button.</li> <li>3. Press the <b>SELECT (+)</b> or <b>(-)</b> to set the time.</li> <li>4. Press the <b>SET</b> button.</li> <li>5. Release the <b>SHIFT</b> button.</li> </ol>	<ol style="list-style-type: none"> <li>1. When <b>CLOCK</b> is pressed, the <b>CLOCK</b> indicator on the display comes on and the clock time blinks.</li> <li>2. The (+) button increases the time whereas the (-) button decreases the time. Pressing the button continuously will change the time in 10 minute intervals.</li> <li>3. When the time is <b>Set</b>, the time display changes from a blinking display to a steady display. The clock starts from 0 seconds.</li> </ol>
<p><b>2</b></p> <p>CLOCK</p>		
<p><b>3</b></p> <p>- SELECT +</p>		
<p><b>4</b></p> <p>SET</p>		
<p><b>5</b></p> <p>SHIFT</p>		

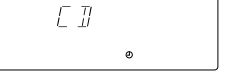
**Caution:**

If a power failure occurs, the clock loses its setting. The clock time is reset to "0:00". "CLOCK" on the display starts blinking. The clock must be reset.



## Setting the Timer

Remote Control	Steps	Explanation/Remarks
<b>1</b>  SHIFT	<b>On the Remote Control</b> 1. Press and hold the <b>SHIFT</b> button until the following procedure is finished.	1. Step 2: The Timer indicator on the display lights up. The blinking " <b>TIMER ON</b> " changes to the On Time setting display.
<b>2</b>  TIMER	2. Press the <b>TIMER</b> button.	 → 
<b>3</b>  - SELECT +	3. Press the <b>SELECT (+)</b> or <b>(-)</b> to set the On Time. 4. Press the <b>SET</b> button.	2. Step 3: Pressing the <b>SELECT (+)</b> or <b>(-)</b> button will advance or decrease the time. Pressing continuously will make the time increases or decreases in 10 minute intervals.
<b>4</b>  SET	5. Press the <b>SELECT (+)</b> or <b>(-)</b> to set the Off Time. 6. Press the <b>SET</b> button.	3. Step 4: " <b>TIMER OFF</b> " blinks on the display and the display changes to the Off Time setting display.
<b>5</b>  - SELECT +	7. Press the <b>SELECT (+)</b> or <b>(-)</b> to select the source. 8. Press the <b>SET</b> button.	 → 
<b>6</b>  SET	9. Press the <b>SELECT (+)</b> or <b>(-)</b> to set the volume level. 10. Press the <b>SET</b> button.	4. Step 5: This will help you to set to the time you want the Unit to be turned off.
<b>7</b>  - SELECT +	11. Release the <b>SHIFT</b> button. Setting completed.	
<b>8</b>  SET	12. Turn the Unit Off to activate the Timer function.	5. Step 6: The name of the source blinks.
<b>9</b>  - SELECT +	13. If you want to remove the timer settings you have set, press the <b>TIMER</b> button while pressing the <b>SHIFT</b> button.	
<b>10</b>  SET		6. Step 7: The display changes as below with each press of the button. <b>↔ TUNER ↔ TUNER REC ↔ CD ↔ TAPE</b>
<b>11</b>  SHIFT		
<b>13</b>  SHIFT + TIMER		<b>TUNER :</b> Selects the last station you were listening to. <b>TUNER REC :</b> Records the last station you were listening to. <b>CD :</b> Plays the last CD you were listening to. <b>TAPE :</b> Plays the last tape you were listening to.
<b>13</b>  SHIFT + TIMER		• In the source <b>TUNER</b> , <b>CD</b> or <b>TAPE</b> the timer is a Daily timer. It will activated every day until the setting is turned off. • In the source <b>TUNER REC</b> , the timer is a Once timer. After the Once timer has been executed, the details of the setting remain stored but the Timer status is set to off.
<b>13</b>  SHIFT + TIMER		7. Step 8 : The volume level blinks on the display.
		
		8. Step 9 : Set to the volume you want.
		
		9. Step 10 : The display returns to the display before you set the timer.
		10. Step 11: Setting completed.
		11. Step 12 : The timer will activate as set after you off the Unit. Before turning off, check that the selected source is ready. If you will be recording a source while you are out, set the volume to 0. Remember to place a tape in Deck B if you intend to record from the tuner ( <b>TUNER REC</b> )

## Setting the SLEEP Timer

The Sleep Timer is used to turn the Unit off after a certain number of minutes when it is playing. This function will let you fall asleep while listening to the music. Thus you will enjoy your sleep without having to worry about the Unit playing until the next morning.

The Sleep Timer can only be operated when the Unit is on and a source is playing.

Remote Control	Steps	Explanation/Remarks
<p><b>1</b></p> 	<p><b>On the Remote Control</b></p> <ol style="list-style-type: none"> <li>1. Press the <b>SLEEP</b> button on the Remote Control.</li> <li>2. Press the <b>SLEEP</b> button repeatedly to select the length of time.</li> <li>3. To Change the <b>SLEEP</b> Timer setting, press the <b>SLEEP</b> button until the number of minutes you want appears.</li> <li>4. To Cancel the <b>SLEEP</b> Timer setting, press the <b>SLEEP</b> button until the <b>SLEEP</b> indicator goes off. Turning off the Unit also cancels the <b>SLEEP</b> timer.</li> </ol>	<ol style="list-style-type: none"> <li>1. The <b>SLEEP</b> indicator will light up on the display.           <div style="text-align: center;">  </div> </li> <li>2. Each time you press the SLEEP button, the number of minutes change in the sequence as shown below.           <p style="text-align: center;">→ 10 → 20 → 30 → 60 → 90 → 120 → Canceled (back to the beginning)</p> <ul style="list-style-type: none"> <li>• When the number of minutes you want appears on the display, wait for 5 seconds until the number of minutes stops blinking and is lighted steadily.</li> <li>• The Unit is now set to turn off after the number of minutes you set.</li> </ul> </li> </ol>

# Using the Microphone

## Unit (Front Panel)

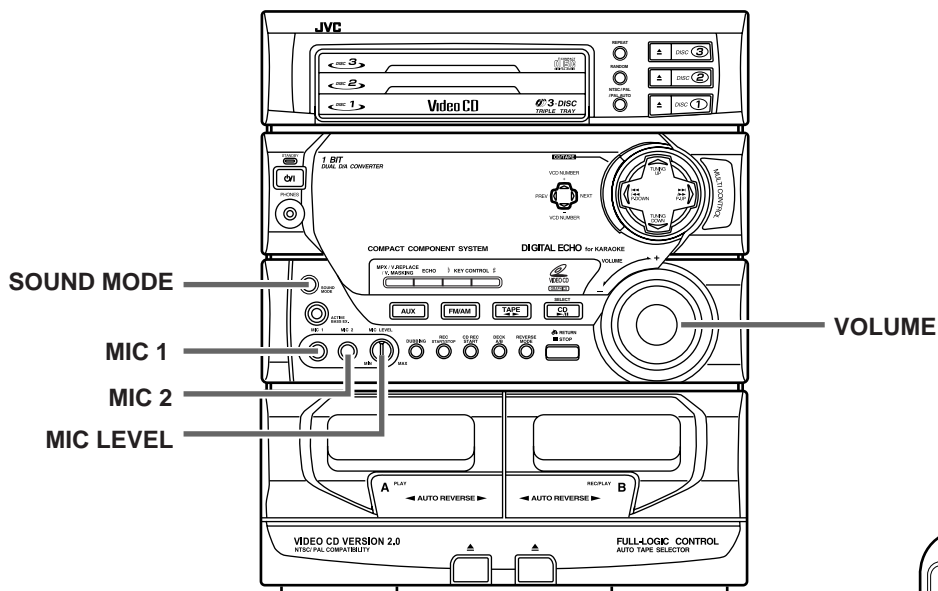

## Remote Control

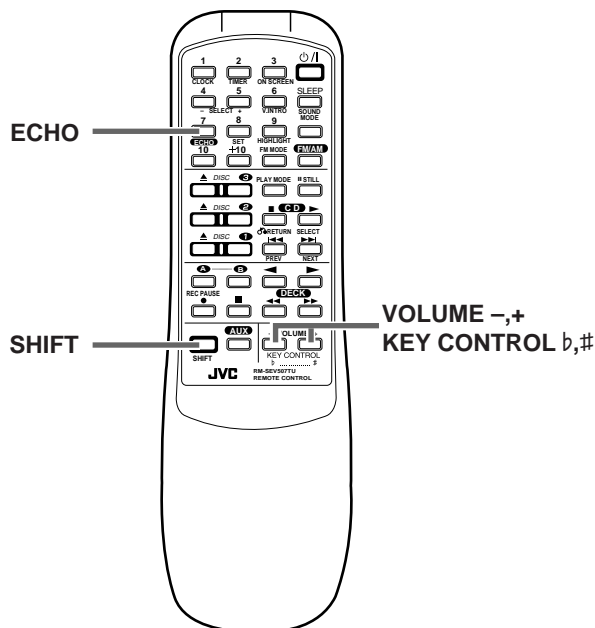

## Display

Source, Sound Mode Volume Level etc.

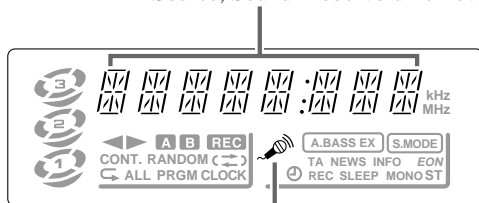

: Karaoke indicator  
 : Echo indicator

When the System is being used, the display shows other items as well. However, we have only shown the items described in this section.

The System includes two microphone terminals, **MIC 1** and **MIC 2**. By attaching a microphone to one or both of these terminals, you can use the System for Karaoke or microphone mixing. You can add echo to the microphone's sound. The **MIC LEVEL** control adjusts the volume for both the **MIC 1** and **MIC 2** at the same time.

**Caution** : Always set the **MIC LEVEL** control to **MIC** when connecting or disconnecting the microphone.





# Singing Along - Karaoke





You can enjoy singing along using conventional audio CDs, CD-Gs, Video CDs or tapes.

## To sing along with conventional audio discs or tapes

### Vocal Masking

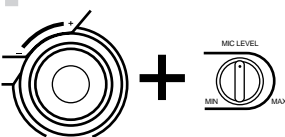
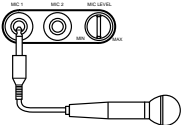
When playing a stereo recorded source such as conventional audio CDs or tapes, you can reduce the lead vocal and replace it with your voice by singing into the microphone. Usually stereo recorded CDs are the best source for Vocal Masking. The following sources are not good for Vocal Masking.

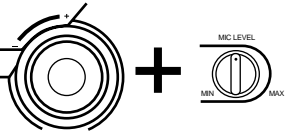
- Monaural sources.
- Multiplex karaoke tapes and discs.
- Poorly dubbed tapes.
- Stereo recorded source, but with only few instruments, with duets, or with strong echo.

Remote Control	Steps	Explanation/Remarks
<p><b>1</b></p>  <p><b>2</b></p>  <p><b>4</b></p>  <p><b>5</b></p>  <p><b>10</b></p> 	<p><b>On the Unit</b></p> <ol style="list-style-type: none"> <li>1. Turn down the <b>MIC LEVEL</b> control and the <b>VOLUME</b> control.</li> <li>2. Connect the microphone (not supplied) into the <b>MIC 1</b> or <b>2</b> jack on the front panel.</li> <li>3. Play the source - CD, tape or others. To play audio CDs, see pages 15 to 20. To play tapes, see pages 27 to 29.</li> <li>4. Press the <b>MPX / V.REPLACE/ V.MASKING</b> button until “<b>V.MASK</b>” appears on the display.</li> <li>5. Turn the <b>MIC LEVEL</b> control and the <b>VOLUME</b> control to adjust the microphone level and the speaker output level.</li> <li>6. Sing into the microphone.</li> <li>7. To apply ECHO to your voice, see “Apply Echo to your voice” on page 39.</li> <li>8. To adjust the music key, see “Adjusting the Music Key Control” on page 39.</li> <li>9. To record your singing along, see “Recording Your Singing Along” on page 40.</li> <li>10. When finish singing, restore the stereo effect by pressing the <b>MPX / V.REPLACE/ V.MASKING</b> button until “<b>NORMAL</b>” appears on the display.</li> </ol>	<ol style="list-style-type: none"> <li>1. When the <b>MPX / V.REPLACE/ V.MASKING</b> button is pressed each time, the display shows the below:           <div style="text-align: center; border: 1px solid black; padding: 5px; margin: 10px 0;"> <p>→ Lch MONO → Rch MONO → REPLACE → V.MASK</p> <p>← NORMAL ←</p> </div> <p><b>Lch MONO</b> : See next page  <b>Rch MONO</b> : See next page  <b>REPLACE</b> : See next page  <b>V.MASK</b> : Reduces the lead vocal            (but never erase it) recorded on a stereo source.  <b>NORMAL</b> : Cancels the Karaoke function.</p> </li> </ol> <div style="border: 1px solid black; padding: 5px; margin-top: 10px;"> <p><b>Notes:</b></p> <ul style="list-style-type: none"> <li>• For preventing howling and squealing when using the microphone, adjust the MIC LEVEL and VOLUME, and try not to point the microphone at the speakers.</li> <li>• When TUNER is selected, Karaoke does not operate.</li> </ul> </div>

# To sing along with Multiplex Karaoke discs or tapes

## MPX (Multiplex) / Vocal Replace Sound

If the source you are going to play is a multiplex karaoke disc or tape, you can use the following two functions - Multiplex Sound and Vocal Replace.





Before playing a source, turn on the TV and select the video input so that you can view the pictures from the System.

### • What is Multiplex Sound?

In a multiplex karaoke disc or tape, the instrumental parts are recorded on the left channel and the vocal parts are recorded on the right channel. With this System, you can select the playback sound with your voice through the microphone.

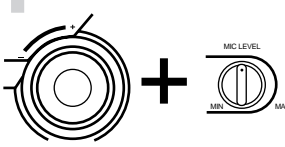
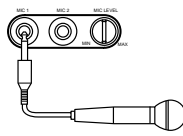

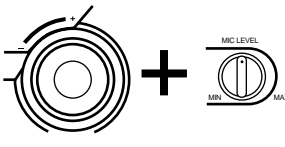
### • What is Vocal Replace?

By using this function, you can replace the lead vocal (recorded on the right channel) while singing along. If you stop singing while a source is still playing, the original lead vocal sound resumes.

Unit	Steps	Explanation/Remarks
<p><b>1</b></p> 	<p><b>On the Unit</b></p> <ol style="list-style-type: none"> <li>Turn down the <b>MIC LEVEL</b> control and the <b>VOLUME</b> control.</li> </ol>	<ol style="list-style-type: none"> <li>When the <b>MPX / V.REPLACE/ V.MASKING</b> button is pressed each time, the display shows the below:           <div style="text-align: center; border: 1px solid black; padding: 5px; margin: 10px 0;"> <span style="margin-right: 10px;">→ Lch MONO →</span> <span style="margin-right: 10px;">→ Rch MONO →</span> <span style="margin-right: 10px;">→ REPLACE →</span> <span style="margin-right: 10px;">→ V.MASK →</span> <span style="margin-left: 10px;">← NORMAL ←</span> </div> </li> </ol>
<p><b>2</b></p> 	<ol style="list-style-type: none"> <li>Connect the microphone (not supplied) into the <b>MIC 1</b> or <b>2</b> jack on the front panel.</li> </ol>	<p><b>Lch MONO :</b> Only the left channel (instrumental parts) are played back through both right and left speakers.</p>
<p><b>4</b></p> 	<ol style="list-style-type: none"> <li>Play the source - CD, tape or others. To play audio CDs, CD-Gs and Video CDs without the PBC function, see pages 15 to 20. To play Video CDs with PBC function, see page 22. To play tapes, see pages 27 to 29.</li> </ol>	<p><b>Rch MONO :</b> Only the right channel (vocal parts) are played back through both right and left speakers.</p>
<p><b>5</b></p> 	<ol style="list-style-type: none"> <li>Press the <b>MPX / V.REPLACE/ V.MASKING</b> button to choose the mode you want to sing along.</li> </ol>	<p><b>REPLACE :</b> Your voice replaces the right channel (vocal parts) when you sing into the microphone.</p>
<p><b>10</b></p> 	<ol style="list-style-type: none"> <li>Turn the <b>MIC LEVEL</b> control and the <b>VOLUME</b> control to adjust the microphone level and the speaker output level.</li> <li>Sing into the microphone.</li> <li>To apply <b>ECHO</b> to your voice, see "Apply Echo to your voice" on page 39.</li> <li>To adjust the music key, see "Adjusting the Music Key Control" on page 39.</li> <li>To record your singing along, see "Recording Your Singing Along" on page 40.</li> <li>When finish singing, restore the stereo effect by pressing the <b>MPX / V.REPLACE/ V.MASKING</b> button until "<b>NORMAL</b>" appears on the display.</li> </ol>	<p><b>V.MASK :</b> This cannot be used for multiplex karaoke sources. Refer to previous page for details.</p> <p><b>NORMAL :</b> Cancels the Karaoke function. Used for conventional stereo sources.</p>

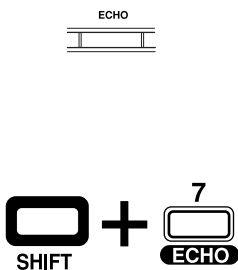

## Apply Echo to Your Voice

Echo can be applied to your voice through the microphone(s).

Remote Control	Steps	Explanation/Remarks
 <p>The diagram shows a rectangular button labeled 'ECHO' with a horizontal line through it. Below it, a remote control button labeled 'SHIFT' is shown next to a button labeled '7 ECHO'.</p>	<p><b>On the Unit</b></p> <ol style="list-style-type: none"> <li>1. Press the <b>ECHO</b> button.</li> <li>2. To Cancel, press the <b>ECHO</b> button again.</li> </ol> <p><b>On the Remote Control</b></p> <ol style="list-style-type: none"> <li>1. Press the <b>ECHO</b> button while pressing the <b>SHIFT</b> button.</li> <li>2. To cancel, press the <b>ECHO</b> button again while pressing the <b>SHIFT</b> button.</li> </ol>	<ol style="list-style-type: none"> <li>1. Each time the ECHO button is pressed (on the Unit or through the Remote Control operation), echo turns on and off . The display will show as below:</li> </ol>  <p><b>ECHO :</b> Echo applies to your voice. The (E) echo indicator lights up on the display.</p> <p><b>OFF :</b> Cancels the echo.</p>



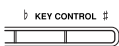

## Adjusting the Music Key Control

The key of the music can be adjusted.

Unit/Remote Control	Steps	Explanation/Remarks
<p><b>1</b></p>  <p><b>1</b></p>  <p><b>2</b></p> 	<p><b>On the Unit</b></p> <ol style="list-style-type: none"> <li>1. Press the <b>KEY CONTROL</b> buttons ( b, # ) repeatedly.</li> <li>2. To lower the key, press the <b>KEY CONTROL</b> ( b ) button repeatedly.</li> <li>3. To raise the key, press the <b>KEY CONTROL</b> ( # ) button repeatedly.</li> <li>4. To Cancel the key adjustment, press the <b>KEY CONTROL</b> buttons ( b, # ) until “<b>KEY 0</b>” appears on the display.</li> </ol> <p><b>On the Remote Control</b></p> <ol style="list-style-type: none"> <li>1. While pressing the <b>SHIFT</b> key, proceed with the following procedures.</li> <li>2. Press the <b>KEY CONTROL</b> buttons ( b, # ) repeatedly.</li> <li>3. To lower the key, press the <b>KEY CONTROL</b> ( b ) button repeatedly.</li> <li>4. To raise the key, press the <b>KEY CONTROL</b> ( # ) button repeatedly.</li> <li>5. To Cancel the key adjustment, press the <b>KEY CONTROL</b> buttons ( b, # ) until “<b>KEY 0</b>” appears on the display.</li> </ol>	<ol style="list-style-type: none"> <li>1. When the <b>KEY CONTROL</b> is pressed each time, the key level (<b>KEY -6</b> to <b>KEY +6</b>) appears on the display.</li> </ol> <p><b>Notes:</b></p> <ul style="list-style-type: none"> <li>• Once the music key is adjusted, the key level will not return to the previously level automatically after playing a song.</li> <li>• The music key cannot be changed while recording.</li> <li>• Once the source is changed, the key level returns to 0.</li> <li>• The Sound Mode will be cancelled if the Karaoke function (multiplex Sound, Vocal Replace, Vocal Masking) is selected.</li> </ul>

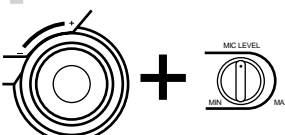
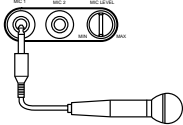
# Recording Your Singing Along

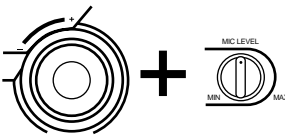
Your singing along can be recorded with the effects created by the Karaoke function.

Unit	Steps	Explanation/Remarks
<p><b>1</b></p>  <p><b>2</b></p>  <p><b>4</b></p>  <p><b>5</b></p>  <p><b>10</b></p> 	<p><b>On the Unit</b></p> <ol style="list-style-type: none"> <li>1. Turn down the <b>MIC LEVEL</b> control and the <b>VOLUME</b> control.</li> <li>2. Connect the microphone (not supplied) into the <b>MIC 1</b> or <b>2</b> jack on the front panel.</li> <li>3. Play the source - CD, tape or others. To play audio CDs, CD-Gs and Video CDs without the PBC function, see pages 15 to 20. To play Video CDs with PBC function, see page 22. To play tapes, see pages 27 to 29.</li> <li>4. Select the Karaoke function available for the source - Stereo or multiplex Karaoke source. Press the <b>MPX / V.REPLACE/ V.MASKING</b> button to select the mode. See pages 37 and 38.</li> <li>5. Turn the <b>MIC LEVEL</b> control and the <b>VOLUME</b> control to adjust the microphone level and the speaker output level.</li> <li>6. Sing into the microphone.</li> <li>7. To apply <b>ECHO</b> to your voice, see “Apply Echo to your voice” on page 39.</li> <li>8. To adjust the music key, see “Adjusting the Music Key Control” on page 39.</li> <li>9. Start recording. Ensure that a tape has been inserted into Deck B to be recorded. For further details on recording, please refer to Standard Recording on page 31.</li> <li>10. When finish singing, restore the stereo effect by pressing the <b>MPX / V.REPLACE/ V.MASKING</b> button until “<b>NORMAL</b>” appears on the display.</li> </ol>	<ol style="list-style-type: none"> <li>1. If you want to change the Karaoke function during recording, stop recording and repeat the same procedure from Steps 4 to 9.</li> </ol>

# Care And Maintenance

## Compact Discs

Handle your compact discs, cassette tapes, and Cassette Deck carefully, and they will last a long time.



- Remove the CD from the case by holding it at the edges while pressing the centre hole lightly.
- Do not touch the shiny surface of the CD, or bend the CD.



- Put the CD back in its case after use to prevent warping.
- Be careful not to scratch the surface of the CD when placing it back in the case.
- Avoid exposure to direct sunlight, temperature extremes, and moisture.



- A dirty CD may not play correctly. If a CD does become dirty, wipe it with a soft cloth in a straight line from centre to edge.

**CAUTION:** Do not use any solvent (for example, conventional record cleaner, spray thinner, benzene, etc.) to clean a CD.

## Moisture Condensation



Moisture may condense on the lens inside the Unit in the following cases:

- After starting the heating in the room.
- In a damp room.
- If the Unit is brought directly from a cold to a warm place.

Should this occur, the Unit may malfunction. In this case, leave the Unit turned on for a few hours until the moisture evaporates, unplug the AC power cord, and then plug it in again.

## General Notes

In general, you will have the best performance by keeping your tapes, CDs, and the mechanism clean.

- Store tapes and CDs in their cases, and keep them in cabinets or on shelves.
- Keep the Cassette Deck's tape doors and the CD trays closed when not in use.

## Cassette Tapes

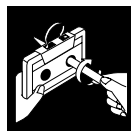

- If the tape is loose in its cassette, take up the slack by inserting a pencil in one of the reels and rotating.
- If the tape is loose, it may get stretched, cut, or caught in the cassette.



- Do not touch the tape surface.



- Do not store the tape:
  - In dusty places
  - In direct sunlight or heat
  - In moist areas
  - On a TV or speaker
  - Near a magnet

## Cassette Deck

- If the heads, capstans, and pinch-rollers of the Cassette Deck become dirty, the following will occur:
  - Loss of sound quality
  - Discontinuous sound
  - Fading
  - Incomplete erasure
  - Difficulty recording
- Clean the heads, capstans, and pinch-rollers using a cotton swab moistened with alcohol.

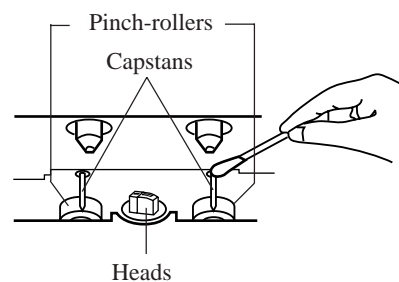

- If the heads become magnetized, the Unit will produce noise or lose high frequencies.
- To demagnetize the heads, turn off the Unit, and use a head demagnetizer (available at electronics and record shops).

# Troubleshooting

- If you are having a problem with your System, check this list for a possible solution before calling for service.
- If you cannot solve the problem from the hints given here, or the Unit has been physically damaged, call a qualified person, such as your dealer, for service.

Symptom	Possible Cause	Action
No sound is heard.	Connections are incorrect, or loose.	Check all connections and make corrections. (See pages 4 - 6.)
Unable to record.	Cassette record protect tabs are removed.	Cover holes on back edge of cassette with tape.
Poor radio reception	<ul style="list-style-type: none"> <li>• The antenna is disconnected.</li> <li>• The AM Loop Antenna is too close to the Unit.</li> <li>• The FM Wire Antenna is not properly extended and positioned.</li> </ul>	<ul style="list-style-type: none"> <li>• Reconnect the antenna securely.</li> <li>• Change the position and direction of the AM Loop Antenna.</li> <li>• Extend FM Wire Antenna to the best reception position.</li> </ul>
The CD skips.	The CD is dirty or scratched.	Clean or replace the CD.
Unable to operate the Remote Control.	<ul style="list-style-type: none"> <li>• The path between the Remote Control and the sensor on the Unit is blocked.</li> <li>• The batteries have lost their charge.</li> </ul>	<ul style="list-style-type: none"> <li>• Remove the obstruction.</li> <li>• Replace the batteries.</li> </ul>
The CD tray cannot be opened.	The main AC power cord is not plugged in.	Plug in the AC power plug.
The CD does not play.	The CD is upside down.	Put the CD in with the label side up.
Operations are disabled.	The built-in microprocessor has malfunctioned due to external electrical interference.	Unplug the Unit then plug it back in.
The cassette door cannot be opened.	During tape playing, the power cord was unplugged.	Plug in the power cord, press the <b>⏻/I</b> button, and then press the <b>▲</b> button.
The image on the TV screen loses its colour.	<b>VIDEO OUT</b> select is unmatching.	Press <b>NTSC / PAL / PAL AUTO</b> button. (See page 6)
The disc sound loses stereo effect.	The MPX sound, Vocal Masking or Vocal Replace function is in use.	Press the <b>MPX/V.REPLACE/V.MASKING</b> button until "NORMAL" appears on the display.
The pictures of the video CD or CD-G is distorted.	When you pause or advance the pictures manually, the pictures are distorted. This is not a malfunction.	

# Specifications

## MX-V508T / MX-V588T Specifications CD/AMP/DECK TUNER UNIT Specifications

CA-V508T/CA-V588T

CA-V508T Silver in colour, CA-V588T Gold in colour

### Amplifier Section

Output Power (IEC 268-3/DIN)	27watts per channel, min. RMS, both channels driven, into 6 ohms at 1 kHz, with no more than 0.9% total harmonic distortion.
Input Sensitivity/Impedance (1 kHz)	
AUX	300 mV/50 kohms
MIC 1	3 mV/4.7 kohms
MIC 2	3 mV/4.7 kohms
Speaker terminals	6 - 16 ohms
Video out (composite)	1.0Vp-p (75Ω)

### Cassette Deck Section

Frequency Response	
Type II (CrO <sub>2</sub> ) :	50 - 14,000 Hz
Type I (NORMAL) :	50 - 14,000 Hz
Wow And Flutter	0.15% (WRMS)

### CD Automatic Changer Section

CD Capacity	3 discs
Dynamic Range	85 dB
Signal-To-Noise Ratio	90 dB
Wow And Flutter	Unmeasurable
Playback disc	Video CD (with/without Playback Control function), CD Graphic, Audio CD

### Tuner Section

FM Tuner	
Tuning Range	87.5 - 108.0 MHz
AM Tuner	
Tuning Range	531 - 1,602 kHz (at 9 kHz channel space) 530 - 1,710 kHz (at 10 kHz channel space)

Dimensions	265 × 315 × 340 mm (W/H/D) (10-7/16 × 12-7/16 × 13-7/16 inches)
------------	--

Mass	7.2 kg (15.9 lbs)
------	-------------------

### Speaker Specifications

SP-V608/SP-V688

SP-V608 Silver in colour, SP-V688 Gold in colour

Type	3-way, 3-speaker bass-reflex type (Magnetically-shielded type)
Speaker	
Tweeter	2 cm (13/16 inches) dome × 1
Mid range	5 cm (2 inches) cone × 1
Woofer	16 cm (6-5/16 inches) cone × 1
Power Handling Capacity	80 Watts
Impedance	6 ohms
Frequency Range	46 - 20,000 Hz
Sound Pressure Level	87 dB/w • m

Dimensions	215 × 315 × 271 mm (W/H/D) (8-1/2 × 12-7/16 × 10-11/16 inches)
------------	---

Mass	3.3 kg (7.3 lbs)
------	------------------

### Accessories

Video Cord (1)
AM Loop Antenna (1)
Remote Control (1)
Batteries R6P (SUM-3)/AA (15F) (2)
FM Wire Antenna (1)
AC Plug Adaptor (except for Hong Kong and China) (1)

### Power Specifications

Power Requirements	AC 110/127/220/230-240 V $\sim$ , adjustable with the voltage selector, 50/60 Hz
Power Consumption	85 watts 12 watts (in standby mode)
Max. Power Consumption	185 watts (Taiwan only)

**Mains (AC) Line Instruction (not applicable for Europe, U.S.A., Canada, Australia, and U.K.)**

**Instrucción sobre la línea de la red (CA) (no aplicable para Europa, EE.UU., Canadá, Australia, ni el Grã-Bretanha)**

**Instrução sobre a tensão da rede eléctrica (CA) (não aplicável para a Europa, os E.U.A., o Canadá, a Austrália e o Reino Unido)**

**主 (AC) 電源線路說明 (不適用於歐洲、美國、加拿大、澳洲及英國型號)**

**تعليمات خط التيار الكهربائي الرئيسي (المتردد) (لا تنطبق على أوروبا والولايات المتحدة الأمريكية وكندا وأستراليا والمملكة المتحدة)**

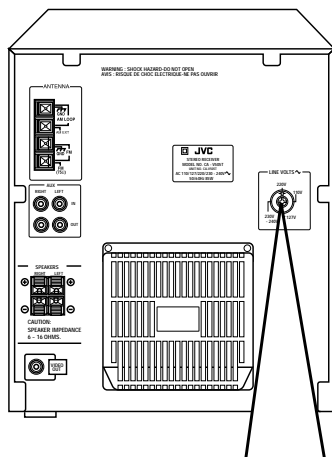

**IMPORTANT for mains (AC) line**

BEFORE PLUGGING IN, do check that your mains (AC) line voltage corresponds with the position of the voltage selector switch provided on the outside of this equipment and, if different, reset the voltage selector switch, to prevent from a damage or risk of fire/electric shock.

**IMPORTANTE para la línea de la red (CA)**

ANTES DE ENCHUFAR EL EQUIPO, compruebe si la tensión de la línea de la red (CA) corresponde con la posición del selector de tensión situado en la parte exterior del equipo, y si es diferente, reajuste el selector de tensión para evitar el riesgo de incendios/descargas eléctricas.

**IMPORTANTE para a ligação à tensão da rede (CA)**

ANTES DE LIGAR O APARELHO A UMA TOMADA DA REDE, verifique se a tensão da rede CA corresponde à posição do seletor de voltagem localizado na parte externa deste equipamento. Caso não corresponda, reajuste o seletor de voltagem a fim de evitar avarias ou riscos de incêndio e choque elétrico.

**有關主 (AC) 電源線路的重要事項**

接插電源以前，務請檢查當地的主 (AC) 電源線路電壓是否和位於本機外面的電壓選擇開關設定的位置一致。如果不一致，即重新設定電壓選擇開閉使符合當地電壓，以免損壞機器或引起火災／觸電的危險。

**هام من اجل خط التيار الكهربائي الرئيسي (المتردد)**  
قبل ادخال قابس الطاقة الكهربائية، تأكد من تطابق منتخب فولطية التيار الكهربائي الرئيسي (المتردد) الموجود على خلفية الجهاز مع فولطية التيار الكهربائي في بلدك. في حالة عدم التطابق، اعد ضبط مفتاح المنتخب الفولطية على فولطية التيار الكهربائي المتردد في بلدك. عدم عمل ذلك، يمكن يؤدي الى حصول ضرر او حريق أو صدمة كهربائية.